

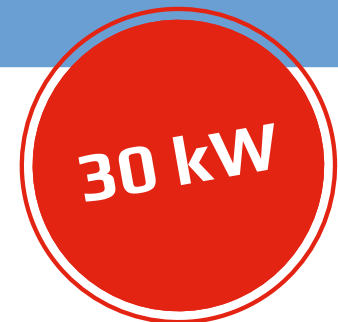

Elektro-Automatik



MANUAL

EA-PSB 10000 4U

Programmable bidirectional
DC Power Supplies

TABLE OF CONTENTS

1. General

1.1	About this document	5
1.1.1	Retention and use	5
1.1.2	Copyright	5
1.1.3	Validity	5
1.1.4	Symbols and warnings in this document	5
1.2	Warranty	5
1.3	Limitation of liability	5
1.4	Disposal of equipment	6
1.5	Product key	6
1.6	Intended usage	7
1.6.1	Symbols and warnings on the device	7
1.7	Safety	8
1.7.1	Safety notices	8
1.7.2	Responsibility of the operator	9
1.7.3	Requirements to the user	9
1.7.4	Responsibility of the user	9
1.7.5	Alarm signals	10
1.7.6	Functionality test	10
1.8	Technical Data	11
1.8.1	Approved operating conditions	11
1.8.2	General technical data	11
1.8.3	Specific technical data	12
1.8.4	Views	16
1.8.5	Control elements	21
1.9	Construction and function	22
1.9.1	General description	22
1.9.2	Block diagram	22
1.9.3	Scope of delivery	23
1.9.4	Accessories	23
1.9.5	Options	23
1.9.6	The control panel (HMI)	24
1.9.7	USB port (rear side)	27
1.9.8	Interface module slot	27
1.9.9	Analog interface	28
1.9.10	“Share BUS” connector	28
1.9.11	“Sense” connector (remote sensing)	28
1.9.12	Master-Slave bus	29
1.9.13	Ethernet port	29
1.9.14	Water cooling	29

2. Installation & commissioning

2.1	Transport and storage	30
2.1.1	Transport	30
2.1.2	Packaging	30
2.1.3	Storage	30
2.2	Unpacking and visual check	30
2.3	Installation	30

2.3.1	Safety procedures before installation and use	30
2.3.2	Preparation	30
2.3.3	Installing the device	32
2.3.4	Connection to water supply (WC models)	33
2.3.5	Connection to AC supply	35
2.3.6	Connection to DC loads or DC sources	37
2.3.7	Grounding of the DC terminal	38
2.3.8	Connection of remote sensing	39
2.3.9	Installation of an interface module	40
2.3.10	Connection of the analog interface	41
2.3.11	Connection of the Share bus	41
2.3.12	Connection of the USB port (rear side)	41
2.3.13	Initial commission	41
2.3.14	Commission after a firmware update or a long period of non-use	41

3. Operation and application

3.1	Terms	42
3.2	Important notes	42
3.2.1	Personal safety	42
3.2.2	General	42
3.3	Operating modes	42
3.3.1	Voltage regulation / Constant voltage	42
3.3.2	Current regulation / constant current / current limiting	43
3.3.3	Power regulation / constant power / power limiting	44
3.3.4	Internal resistance regulation (source mode)	44
3.3.5	Resistance regulation / constant resistance (sink mode)	45
3.3.6	Sink-source mode switching	45
3.3.7	Dynamic characteristics and stability criteria	45
3.4	Alarm conditions	46
3.4.1	Power Fail	46
3.4.2	Overtemperature	46
3.4.3	Overvoltage protection	46
3.4.4	Overcurrent protection	46
3.4.5	Overpower protection	46
3.4.6	Safety OVP	47
3.4.7	Share bus fail	47
3.5	Manual operation	48
3.5.1	Switching on the device	48
3.5.2	Switching the device off	48
3.5.3	Configuration via the menu	48
3.5.4	Adjustment limits	57
3.5.5	Changing the operating mode	57
3.5.6	Manual adjustment of set values	58

3.5.7	Switching the DC terminal on or off	59
3.5.8	Recording to USB stick (logging)	59
3.5.9	The quick menu	60
3.5.10	The graph	61
3.6	Remote control	62
3.6.1	General	62
3.6.2	Control locations	62
3.6.3	Remote control via a digital interface	62
3.6.4	Remote control via the analog interface	64
3.7	Alarms and monitoring	69
3.7.1	Definition of terms	69
3.7.2	Device alarm and event handling	69
3.8	Locking the control panel (HMI)	72
3.9	Locking the adjustment limits and user profiles	72
3.10	Loading and saving user profiles	73
3.11	The function generator	74
3.11.1	Introduction	74
3.11.2	General	74
3.11.3	Method of operation	75
3.11.4	Manual operation	76
3.11.5	Sine wave function	77
3.11.6	Triangular function	77
3.11.7	Rectangular function	78
3.11.8	Trapezoidal function	79
3.11.9	DIN 40839 function	79
3.11.10	Arbitrary function	80
3.11.11	Ramp function	84
3.11.12	IU table function (XY table)	85
3.11.13	Simple PV (photovoltaics) function	86
3.11.14	FC table function (fuel cell)	88
3.11.15	Extended PV function according to EN 50530	89
3.11.16	Battery test function	95
3.11.17	MPP tracking function	98
3.11.18	Remote control of the function generator	100
3.12	Other applications	101
3.12.1	Parallel operation in master-slave (MS)	101
3.12.2	Series connection	105

4. Service and maintenance

4.1	Maintenance / cleaning	106
4.1.1	Battery replacement	106
4.2	Fault finding / diagnosis / repair	106
4.2.1	Firmware updates	106
4.2.2	Trouble-shooting device problems	107

5. Contact and support

5.1	General	108
5.2	Contact options	108

The part of this document that deals with the handling of features on the control panel is only valid for devices with firmwares "KE: 3.02", "HMI: 3.02" and "DR: 1.0.2.20" or higher.

1. General

1.1 About this document

1.1.1 Retention and use

This document is to be kept in the vicinity of the equipment for future reference and explanation of the operation of the device. This document is to be delivered and kept with the equipment in case of change of location and/or user.

The most recent issue of this document can be found online, on our website.

1.1.2 Copyright

Modification and partial or complete usage of this PDF document for other purposes as intended are forbidden and breach may lead to legal process.





1.1.3 Validity

This manual is valid for the following equipment and its variants:

Model	Model	Model	Model
EA-PSB 10010-1000 4U	EA-PSB 10200-420 4U	EA-PSB 10750-120 4U	EA-PSB 11500-60 4U
EA-PSB 10060-1000 4U	EA-PSB 10360-240 4U	EA-PSB 10920-125 4U	EA-PSB 12000-40 4U
EA-PSB 10080-1000 4U	EA-PSB 10500-180 4U	EA-PSB 11000-80 4U	

1.1.4 Symbols and warnings in this document

Warning and safety notices as well as general notices in this document are shown in a box with a symbol as follows. The symbols are also valid, where placed, also to mark specific spots on the device:

	Symbol for a life threatening danger (electric shock hazard)
	Symbol for risk (of damage to the equipment). If placed on the device it requests the user to read the operating guide prior to start operation.
	Symbol for general safety notices (instructions and damage protection bans) or important information for operation
	<i>Symbol for general notices</i>

1.2 Warranty

EA Elektro-Automatik guarantees the functional competence of the applied technology and the stated performance parameters. The warranty period begins with the delivery of free from defects equipment.

Terms of guarantee are included in the general terms and conditions (TOS) of EA Elektro-Automatik.

1.3 Limitation of liability

All statements and instructions in this manual are based on current norms and regulations, up-to-date technology and our long term knowledge and experience. The manufacturer accepts no liability for losses due to:

- Usage for purposes other than designed
- Use by untrained personnel
- Rebuilding by the customer
- Technical changes
- Use of not authorized spare parts

The actual delivered device(s) may differ from the explanations and diagrams given here due to latest technical changes or due to customized models with the inclusion of additionally ordered options.

1.4 Disposal of equipment

A piece of equipment which is intended for disposal must, according to European laws and regulations (ElektroG, WEEE) be returned to the manufacturer for scrapping, unless the person operating the piece of equipment or another, delegated person is conducting the disposal. Our equipment falls under these regulations and is accordingly marked with the following symbol:



The device contains a Lithium battery cell. Disposal of that battery follows the above stated rule or specific local regulations.

1.5 Product key

Decoding of the product description on the label, using an example:

EA-PSB 10080 - 1000 4U xxx

	Options and special versions: WC = Water cooling installed US208V = Special model for 208 V AC grid
	Construction (only stated on type label): 4U = 19" frame with 4 height units
	Maximum current of the device in Ampere
	Maximum voltage of the device in Volt ("10080" = 80 V)
	Series: 10 = Series 10000
	Type identification: PSB = Power Supply Bidirectional

1.6 Intended usage

The equipment is intended to be used only as a variable voltage and current source or only as a variable current sink. Furthermore it's only intended to be used installed and operated in suitable equipment (19" rack or similar), together with a rigid, non-retractable AC supply connection.





Typical application for a voltage source is DC power supply to any relevant user, including when used as battery charger to test charge various battery types, and for current sinks the replacement of an ohmic resistor by an adjustable electronic DC load in order to load relevant voltage and current sources of any type.

Additionally to the functionality of the equipment as source or sink of electrical energy on the DC side, all models in this series are also so-called recuperating devices and thus not just drain energy on the AC side, but also source energy when being sinks on the DC side. This is where the term "bidirectional" comes from. In sink mode the devices become energy recoverers, but are not defined or considered as energy generation equipment.



- Claims of any sort due to damage caused by non-intended usage will not be accepted
- All damage caused by non-intended usage is solely the responsibility of the operator

1.6.1 Symbols and warnings on the device

Decal	Explanation
 <div style="border: 1px solid black; padding: 5px;"> <p>⚠ DANGER RISK OF ELECTRIC SHOCK Disconnect all sources of supply prior to servicing.</p> </div>	This warning is primarily related to the reconfiguration of the device on the DC terminal which, for safety reasons, requires to also cut the device from AC (external main switch). The same applies to disconnection and reconnection of the AC terminal.
 <div style="border: 1px solid black; padding: 5px;"> <p>⚠ DANGER Capacitors on DC, storing voltage! Discharge for 10 sec then ground before working.</p> </div>	Even after disconnection of the DC terminal from an external source there can still be dangerous voltage potential present between the DC terminal poles and/or between DC and the enclosure. For safety reasons the DC terminal must be short-circuited after the capacitors have been discharged and it must also be grounded, i. e. connected to PE.
 <div style="border: 1px solid black; padding: 5px;"> <p>⚠ WARNING ELECTRICAL HAZARDS Authorized personnel only.</p> </div>	There can always be a voltage potential on metallic, openly touchable parts on electrical devices, though the voltage level may not be hazardous. Caution is still advisable, as these potential can still cause mild electrical shocks or sparking.
 <div style="border: 1px solid black; padding: 5px;"> <p>⚠ WARNING Read and understand the operating guide before using this device. Non-adherence of the instructions in the operating guide can result in serious injury or death.</p> </div>	This is valid for any use of the device.

Mortal danger - Hazardous voltage



- **Electrical equipment operation means that some parts accessible on the outside of the device can be under high voltage. Therefore all parts under voltage must be covered during operation! This basically applies to all models, except for the 10 V and 60 V models according to SELV.**
- **The DC terminal is isolated from the AC input and not connected to ground internally. Hence there can be dangerous potential between the DC poles and PE, for instance caused by a connected external source application. Due to charged capacitors this could even be true if the DC output or the device are already switched off.**
- **Do not insert any object, particularly metallic, through the ventilator slots!**
- **For every reconfiguration on the AC or DC connectors, specifically those which can have a dangerous voltage potential, the device must be cut completely from the AC supply (main switch on the distant end of the AC cable); it doesn't suffice to only use the power switch on the front**
- **Always follow 5 safety rules when working with electric devices:**
 - **Disconnect completely**
 - **Secure against reconnection**
 - **Verify that the system is dead**
 - **Carry out earthing and short-circuiting**
 - **Provide protection from adjacent live parts**



- Avoid any use of liquids near the equipment. Protect the device from wet, damp and condensation.
- Do not connect external power sources with reversed polarity to the DC terminal! The equipment will be damaged, even when completely powered off.
- Never connect external power sources to the DC terminal that can generate a higher voltage than the rated voltage of the device!
- Never insert a network cable which is connected to Ethernet or its components into the master-slave sockets on the rear side of the device!



- The equipment must only be used as intended
- The equipment is only approved for use within the connection limits stated on the product label.
- ESD regulations must be applied when plugging interface cards or modules into the relative slot
- Interface cards or modules may only be attached or removed after the device is switched off. It's not necessary to open the device.
- Always configure the various protecting features against overcurrent, overvoltage etc. for sensitive loads to what the target application requires!
- When operating the device as electronic load: always make sure that the energy recovery can feed back the inverted energy and that it does not switch to isolated operation. For situations of isolated operation a supervision device (grid protection) has to be installed
- It's not allowed to run the device on AC sources such as generators or UPS equipment. It must only be connected to a power grid!
- When controlling the device manually on the HMI while it's connected to any controlling unit (PLC, PC etc.) via any analog or digital interface, that controlling unit could take over remote control anytime; for safety reasons it's recommended to block remote control by activating the so-called local mode (also see "3.5. Manual operation" and "3.5.3. Configuration via the menu")

1.7.2 Responsibility of the operator

Operator is any natural or legal person who uses the equipment or delegates the usage to a third party, and is responsible during its usage for the safety of the user, other personnel or third parties.

The equipment is in industrial operation. Therefore the operators are governed by the legal safety regulations. Alongside the warning and safety notices in this manual the relevant safety, accident prevention and environmental regulations must also be applied. In particular the operator has to

- be acquainted with the relevant job safety requirements
- identify other possible dangers arising from the specific usage conditions at the work station via a risk assessment
- introduce the necessary steps in the operating procedures for the local conditions
- regularly control that the operating procedures are current
- update the operating procedures where necessary to reflect changes in regulation, standards or operating conditions.
- define clearly and unambiguously the responsibilities for operation, maintenance and cleaning of the equipment.
- ensure that all employees who use the equipment have read and understood the manual. Furthermore the users are to be regularly schooled in working with the equipment and the possible dangers.
- provide all personnel who work with the equipment with the designated and recommended safety equipment

Furthermore, the operator is responsible for ensuring that the device is at all times technically fit for use.

1.7.3 Requirements to the user

Any activity with equipment of this type may only be performed by persons who are able to work correctly and reliably and satisfy the requirements of the job.

- Persons whose reaction capability is negatively influenced by e.g. drugs, alcohol or medication may not operate the equipment.
- Age or job related regulations valid at the operating site must always be applied.



Danger for unqualified users

Improper operation can cause person or object damage. Only persons who have the necessary training, knowledge and experience may use the equipment.

The group of people allowed to operate the equipment is additionally limited to:

Delegated persons: these are persons who have been properly and demonstrably instructed in their tasks and the attendant dangers.

Qualified persons: these are persons who are able through training, knowledge and experience as well as knowledge of the specific details to carry out all the required tasks, identify dangers and avoid personal and other risks.

1.7.4 Responsibility of the user

The equipment is in industrial operation. Therefore the operators are governed by the legal safety regulations. Alongside the warning and safety notices in this manual the relevant safety, accident prevention and environmental regulations must also be applied. In particular the users of the equipment:

- must be informed of the relevant job safety requirements
- must work to the defined responsibilities for operation, maintenance and cleaning of the equipment
- before starting work must have read and understood the operating manual

1.7.5 Alarm signals

The equipment offers various possibilities for signaling alarm conditions, however, not for danger situations. The signals may be optical (on the display as text or via LED), acoustic (piezo buzzer) or electronic (pin/status output of an analog interface). All alarms will cause the device to switch off the DC terminal. For details about the different alarms refer to section "3.4. Alarm conditions".

The meaning of the signals is as follows:

Signal OT (OverTemperature)	<ul style="list-style-type: none"> • Overheating of the device • DC terminal will be switched off • Non-critical
Signal OVP / SOVP (OverVoltage)	<ul style="list-style-type: none"> • Overvoltage shutdown of the DC terminal due to high voltage entering the device or generated by the device itself due to a defect • Critical! The device and/or the load could be damaged
Signal OCP (OverCurrent)	<ul style="list-style-type: none"> • Shutdown of the DC terminal due to excess of the preset limit • Non-critical, protects the load or source from excessive current consumption
Signal OPP (OverPower)	<ul style="list-style-type: none"> • Shutdown of the DC terminal due to excess of the preset limit • Non-critical, protects the load or source from excessive power consumption
Signal PF (Power Fail)	<ul style="list-style-type: none"> • DC terminal shutdown due to AC undervoltage or defect in the AC section • Critical on overvoltage! AC section could be damaged
Signal MSP (Master-Slave Protection)	<ul style="list-style-type: none"> • DC terminal shutdown due to communication problems on the master-slave bus • Non-critical
Signal SF (Share Bus Fail)	<ul style="list-style-type: none"> • DC terminal shutdown due to signal distortion on the Share bus • Non-critical

1.7.6 Functionality test

The operator of the device must decide when to check the device for correct functionality, by whom and how often. The when could either be before every use or after it has been relocated or reconfigured or perhaps in a defined interval.



Should the set values not be adjustable as instructed below it could simply be due to adjustment limits interfering. See "3.5.4. Adjustment limits". When reaching a limit when adjusting value, the device would indicate in the display.

The test procedure would always be like this:

1. Disconnect all cables (DC, Sense, Share bus, analog interface, USB), except for AC
2. Connect a suitable voltage meter to the DC terminal
3. Switch the device on, adjust a voltage of 10% U_{Nom} while the current and power set values all should be at maximum, switch the DC output on and measure the voltage with the multimeter and compare. Also check what the actual voltage on the display shows.
4. Repeat the same thing at 100% U_{Nom} .
5. Switch the DC output off and bridge the DC terminal with a cable or copper rails of suitable current capability of at least I_{Nom} . If available, put a current measuring device (transducer, current probe).
6. Adjust the current for source mode to 10% I_{Nom} , switch the DC output on and measure the current with the external measuring device, if available and compare the measured current to the actual and set value of current on the display or at least compare the actual current on display with the set value.
7. Repeat the same thing at 100% I_{Nom} .

Only if the current and voltage are supplied by the device as adjustable in the range of 0-100% FS, the device can be considered as correctly operational.

1.8 Technical Data

1.8.1 Approved operating conditions

1.8.1.1 Ambiance

The allowed ambient temperature range for operation is 0 °C (32 °F) to 50 °C (122 °F). During storage or transport, the allowed range extends to -20 °C (-4 °F) to 70 °C (158 °F). In case water condensation occurred due to transport, the device must be acclimatized prior to operation for at least 2 hours, ideally in a place with good air circulation.

The device is intended to be operation in dry rooms. It must not be exposed or operated to extreme dust, high air humidity, danger of explosion and aggressive chemicals polluting the air. The operating position isn't arbitrary (see "2.3.3. Installing the device"), but in any case it requires a sufficient air circulation. The device is allowed to be operated in altitude up to 2000 m (approx. 6,560 ft) above sea level. Technical specifications (here: ratings), when given with tolerance, are valid for a unit warmed up for at least 30 minutes and for an ambient temperature of 23 °C (73 °F). Specifications without tolerance are typical values from an average device.

1.8.1.2 Cooling

Power dissipated inside the device heats up air circulating through the device. With the air-cooled versions a fan at the end of an air flow channel, in which a cooling block is placed, pulls the air through the device. Entry is on the front, exhaust at the back. Depending on the internal temperature, the fan speed is automatically regulated up or down, whereas a certain minimum speed is maintained because some internal components even heat up when the device is idle.

Dust in the air can obstruct the air flow with time, thus it's important to keep the air flow unimpeded at least outside of the device by leaving sufficient room behind it. Since it's usually installed inside cabinets, the cabinet doors are required to be meshed.

At the same time, the ambient temperature should be kept at low levels, perhaps by external means such as an air condition. Should the device heat up internally and the cooling block temperature exceed 80 °C (160 °F), the device will protect itself from overheating by automatically switching off the power stage. It could then only continue to operate and switch the power stage on again after cooling down for some time.

For the water-cooled versions, water is the main cooling agent, flowing through the internal cooling blocks. The air inside the almost hermetically body circulates, engaged by fans, to cool the remaining components not sitting on the cooling blocks, but heat up over time.

1.8.2 General technical data

Display: Color TFT touch screen with gorilla glass, 5", 800pt x 480pt, capacitive
Controls: 2 rotary knobs with pushbutton function, 1 pushbutton

1.8.3 Specific technical data

General specifications	
AC input	
Voltage, Phases	Range 1: 208 V, $\pm 10\%$, 3ph AC (with DC output power derating to 18 kW) Range 2: 380 - 480 V, $\pm 10\%$, 3ph AC
Frequency	45 - 65 Hz
Power factor	ca. 0.99
Leakage current	<10 mA
Inrush current / Phase current	≤ 56 A
Overvoltage category	2
DC output static	
Load regulation CV	$\leq 0.05\%$ FS (0 - 100% load, constant output voltage and constant temperature)
Line regulation CV	$\leq 0.01\%$ FS (208 V - 480 V AC $\pm 10\%$ supply voltage, constant load and constant temperature)
Stability CV	$\leq 0.02\%$ FS (during 8 h of operation, after 30 minutes warm-up, at constant output voltage, load and temperature)
Temperature coefficient CV	≤ 30 ppm/ $^{\circ}$ C (after 30 minutes of warm-up)
Compensation (remote sense)	$\leq 5\%$ U_{Nominal}
Load regulation CC	$\leq 0.1\%$ FS (0 - 100% load, constant output voltage and constant temperature)
Line regulation CC	$\leq 0.01\%$ FS (208 V - 480 V AC $\pm 10\%$ supply voltage, constant load and constant temperature)
Stability CC	$\leq 0.02\%$ FS (during 8 h of operation, after 30 minutes warm-up, at constant output voltage, load and temperature)
Temperature coefficient CC	≤ 50 ppm/ $^{\circ}$ C (after 30 minutes of warm-up)
Load regulation CP	$\leq 0.3\%$ FS (0 - 100% load, constant output voltage and constant temperature)
Load regulation CR	$\leq 0.3\%$ FS + 0.1% FS current (0 - 100% load, constant output voltage and constant temperature)
Protective functions	
OVP	Overvoltage protection, adjustable 0 - 110% U_{Nominal}
OCP	Overcurrent protection, adjustable 0 - 110% I_{Nominal}
OPP	Overpower protection, adjustable 0 - 110% P_{Nominal}
OT	Overtemperature protection (DC output shuts down in case of insufficient cooling)
DC output dynamic	
Rise time 10 - 90% CV	≤ 10 ms
Fall time 90 - 10% CV	≤ 10 ms
Rise time 10 - 90% CC	≤ 2 ms
Fall time 90 - 10% CC	≤ 2 ms
Display accuracy	
Voltage	$\leq 0.05\%$ FS
Current	$\leq 0.1\%$ FS
Insulation	
AC input to DC output	3750 Vrms (1 minute, creepage distance >8 mm) *1
AC input to case (PE)	2500 Vrms
DC output to case (PE)	Depending on the model, see model tables
DC output to interfaces	1000 V DC (models up to 360 V rating), 1500 V DC (models from 500 V rating)
Interfaces digital	
Built-in, galvanically isolated	USB, Ethernet (100 MBit) for communication, 1x USB host for data acquisition
Optional, galvanically isolated	CAN, CANopen, RS232, ModBus TCP, Profinet, Profibus, EtherCAT, Ethernet
Interfaces analog	
Built-in, galvanically isolated	15 pole D-Sub
Signal range	0 - 10 V or 0 - 5 V (switchable)
Inputs	U, I, P, R, remote control on/off, DC output on/off, resistance mode on/off
Outputs	Monitor U and I, alarms, reference voltage, DC output status, CV/CC regulation mode
Accuracy U / I / P / R	0 - 10 V: $\leq 0.2\%$, 0 - 5 V: $\leq 0.4\%$

*1 Models up to 80 V DC rating have reinforced insulation while all other models from 200 V DC rating have basic insulation

General specifications	
Device configuration	
Parallel operation	Up to 64 units of any power class in series 10000, with master-slave bus and Share bus
Safety and EMC	
Safety	EN 61010-1 IEC 61010-1 UL 61010-1 CSA C22.2 No 61010-1 BS EN 61010-1
EMC	EN 55011, class B CISPR 11, class B FCC 47 CFR part 15B, unintentional radiator, class B EN 61326-1 include tests according to: - EN 61000-4-2 - EN 61000-4-3 - EN 61000-4-4 - EN 61000-4-5 - EN 61000-4-6
Safety protection class	1
Ingress Protection	IP20
Environmental conditions	
Operating temperature	0 - 50 °C (32 - 122 °F)
Storage temperature	-20 - 70 °C (-4 - 158 °F)
Humidity	≤80% relative humidity, non-condensing
Altitude	≤2000 m (≤6,600 ft)
Pollution degree	2
Mechanical construction	
Cooling	Forced air flow from front to rear (temperature controlled fans), optional water cooling
Dimensions (W x H x D)	Enclosure: 19" x 4U x 668 mm (26.3 in) Total: 19" x 4U x min. 785 mm (31 in)
Weight	50 kg (110 lb)
Weight with water cooling	56 kg (126 lb)

Technical specifications	PSB 10010-1000	PSB 10060-1000	PSB 10080-1000	PSB 10200-420
DC output				
Voltage range	0 - 10 V	0 - 60 V	0 - 80 V	0 - 200 V
Ripple in CV (rms)	≤25 mV (BW 300 kHz)	≤25 mV (BW 300 kHz)	≤25 mV (BW 300 kHz)	≤40 mV (BW 300 kHz)
Ripple in CV (pp)	≤320 mV (BW 20 MHz)	≤320 mV (BW 20 MHz)	≤320 mV (BW 20 MHz)	≤300 mV (BW 20 MHz)
U_{Min} for I_{Max} (sink)	0.62 V	0.62 V	0.62 V	1.8 V
Current range	0 - 1000 A	0 - 1000 A	0 - 1000 A	0 - 420 A
Power range	0 - 10000 W	0 - 30000 W	0 - 30000 W	0 - 30000 W
Resistance range	0.003 Ω - 5 Ω	0.003 Ω - 5 Ω	0.003 Ω - 5 Ω	0.0165 Ω - 25 Ω
Output capacitance	25380 μF	25380 μF	25380 μF	5400 μF
Efficiency sink/source (up to)	93.8% *1	95.1% *1	95.5% *1	95.3% *1
Insulation				
Negative DC pole <-> PE	±600 V DC	±600 V DC	±600 V DC	±1000 V DC
Positive DC pole <-> PE	+600 V DC	+600 V DC	+600 V DC	+1000 V DC
Article numbers				
Standard	30000810	30000800	30000801	30000802
Standard + Water Cooling	30000830	30000820	30000821	30000822

*1 At 100% power and 100% output voltage

Technical specifications	PSB 10360-240	PSB 10500-180	PSB 10750-120	PSB 10920-125
DC output				
Voltage range	0 - 360 V	0 - 500 V	0 - 750 V	0 - 920 V
Ripple in CV (rms)	≤55 mV (BW 300 kHz)	≤70 mV (BW 300 kHz)	≤200 mV (BW 300 kHz)	≤250 mV (BW 300 kHz)
Ripple in CV (pp)	≤320 mV (BW 20 MHz)	≤350 mV (BW 20 MHz)	≤800 mV (BW 20 MHz)	≤1200 mV (BW 20 MHz)
U_{Min} for I_{Max} (sink)	2.5 V	1.1 V	1.2 V	2 V
Current range	0 - 240 A	0 - 180 A	0 - 120 A	0 - 125 A
Power range	0 - 30000 W	0 - 30000 W	0 - 30000 W	0 - 30000 W
Resistance range	0.05 Ω - 90 Ω	0.08 Ω - 170 Ω	0.2 Ω - 370 Ω	0.25 Ω - 550 Ω
Output capacitance	1800 μF	675 μF	450 μF	100 μF
Efficiency sink/source (up to)	95.8% *1	96.5% *1	96.5% *1	96.5% *1
Insulation				
Negative DC pole <-> PE	±1000 V DC	±1500 V DC	±1500 V DC	±1500 V DC
Positive DC pole <-> PE	+1000 V DC	+2000 V DC	+2000 V DC	+2000 V DC
Article numbers				
Standard	30000803	30000804	30000805	30000809
Standard + Water Cooling	30000823	30000824	30000825	30000829

*1 At 100% power and 100% output voltage

Technical specifications	PSB 11000-80	PSB 11500-60	PSB 12000-40	
DC output				
Voltage range	0 - 1000 V	0 - 1500 V	0 - 2000 V	
Ripple in CV (rms)	≤300 mV (BW 300 kHz)	≤400 mV (BW 300 kHz)	≤500 mV (BW 300 kHz)	
Ripple in CV (pp)	≤1600 mV (BW 20 MHz)	≤2400 mV (BW 20 MHz)	≤3000 mV (BW 20 MHz)	
U_{Min} for I_{Max} (sink)	3.4 V	3.2 V	3.7 V	
Current range	0 - 80 A	0 - 60 A	0 - 40 A	
Power range	0 - 30000 W	0 - 30000 W	0 - 30000 W	
Resistance range	0.4 Ω - 650 Ω	0.8 Ω - 1500 Ω	1.7 Ω - 2700 Ω	
Output capacitance	200 μF	75 μF	50 μF	
Efficiency sink/source (up to)	95.8% *1	96.5% *1	96.5% *1	
Insulation				
Negative DC pole <-> PE	±1500 V DC	±1500 V DC	±1500 V DC	
Positive DC pole <-> PE	+2000 V DC	+2000 V DC	+2000 V DC	
Article numbers				
Standard	30000806	30000807	30000808	
Standard + Water Cooling	30000826	30000827	30000828	

*1 At 100% power and 100% output voltage

1.8.4 Views
 1.8.4.1 Technical drawings PSB 10000 4U ≤200 V

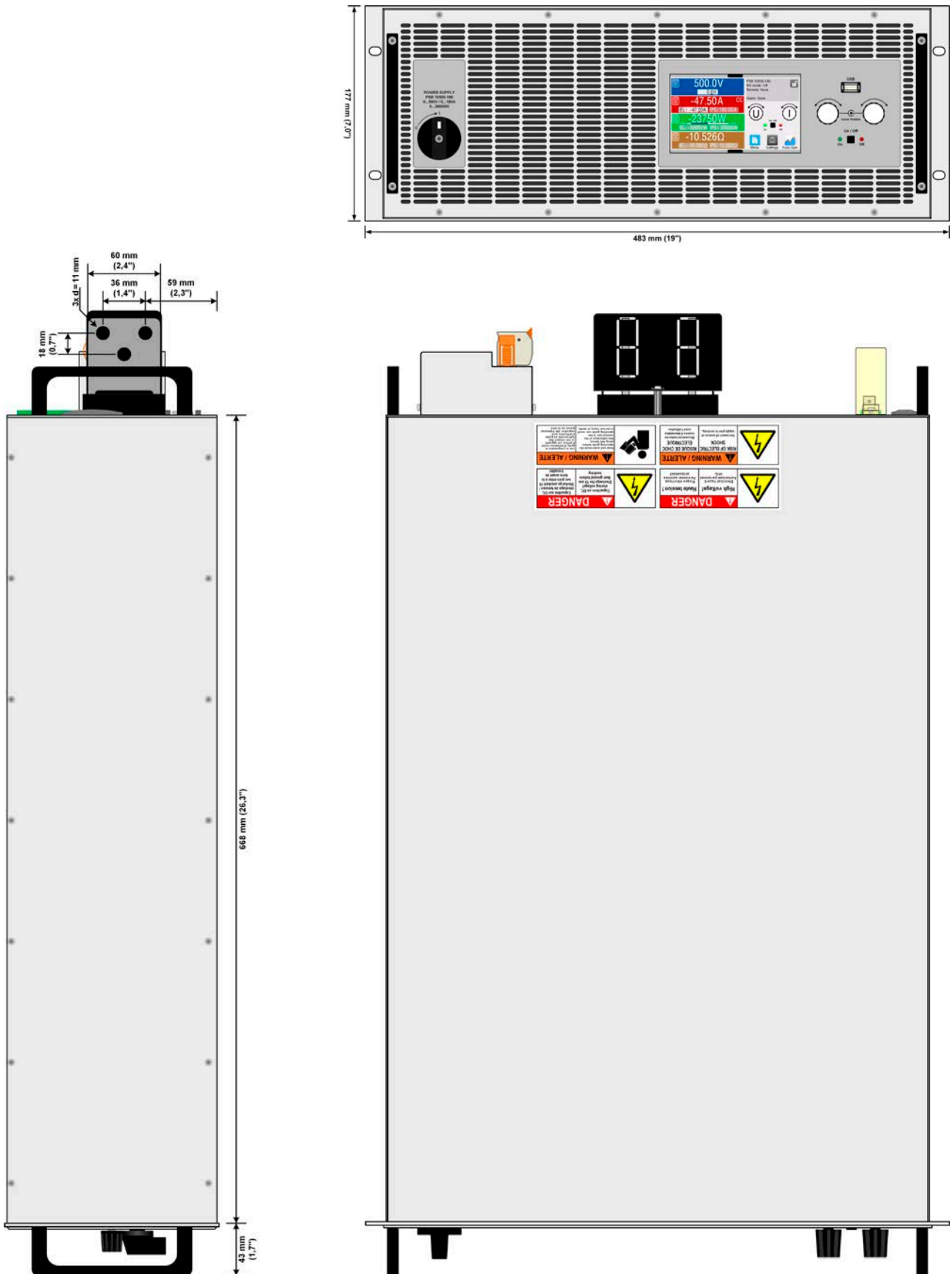

1.8.4.2 Front panel description PSB 10000 4U

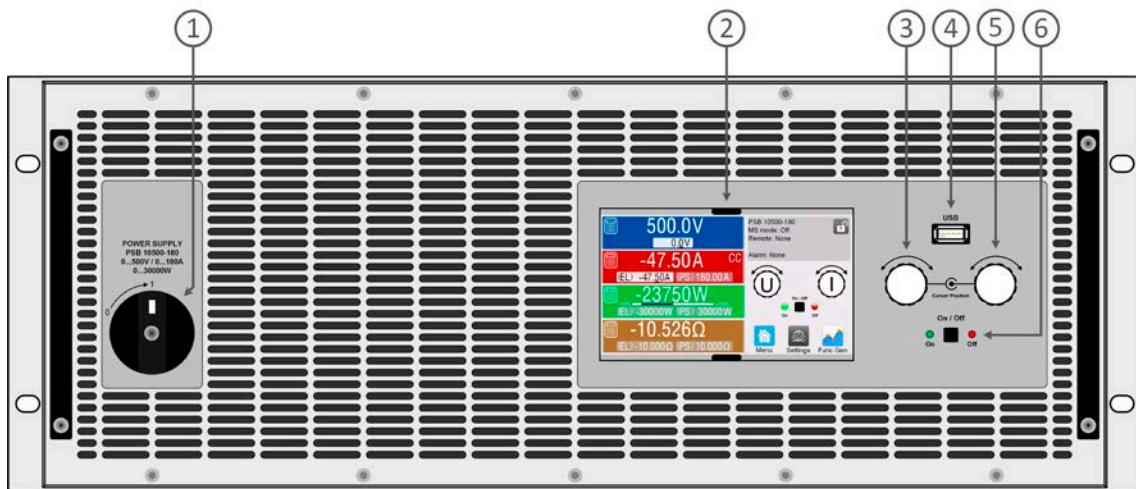

1. Power switch
2. TFT control interface, interactive operation and display
3. Rotary knob with push-button action, for settings and control
4. USB host, uses USB sticks for data logging and sequencing
5. Rotary knob with push-button action, for settings and control
6. On / Off push-button with LED status display

1.8.4.3 Rear panel description PSB 10000 4U $\leq 200\text{ V}$

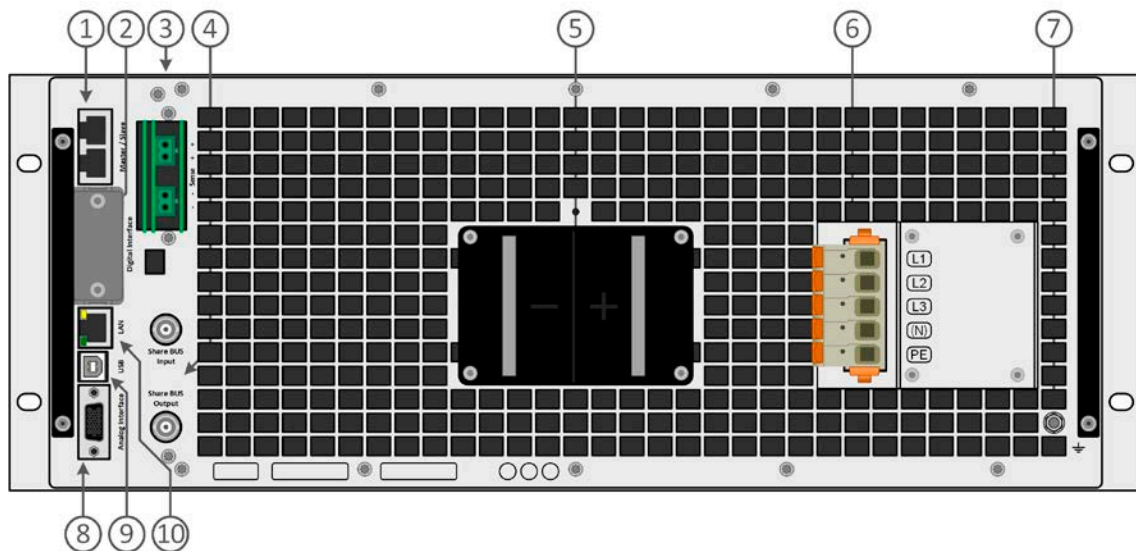

1. Master-Slave bus connectors to set up a system for parallel connection
2. Slot for interfaces
3. Remote sense connectors
4. Share bus connectors to set up a system for parallel connection
5. DC output connector (copper blades)
6. AC input connector
7. Grounding connection screw (PE)
8. Connector (DB15 female) for isolated analog programming, monitoring and other functions
9. USB interface
10. Ethernet interface

1.8.4.4 Technical drawings PSB 10000 4U ≥ 360 V

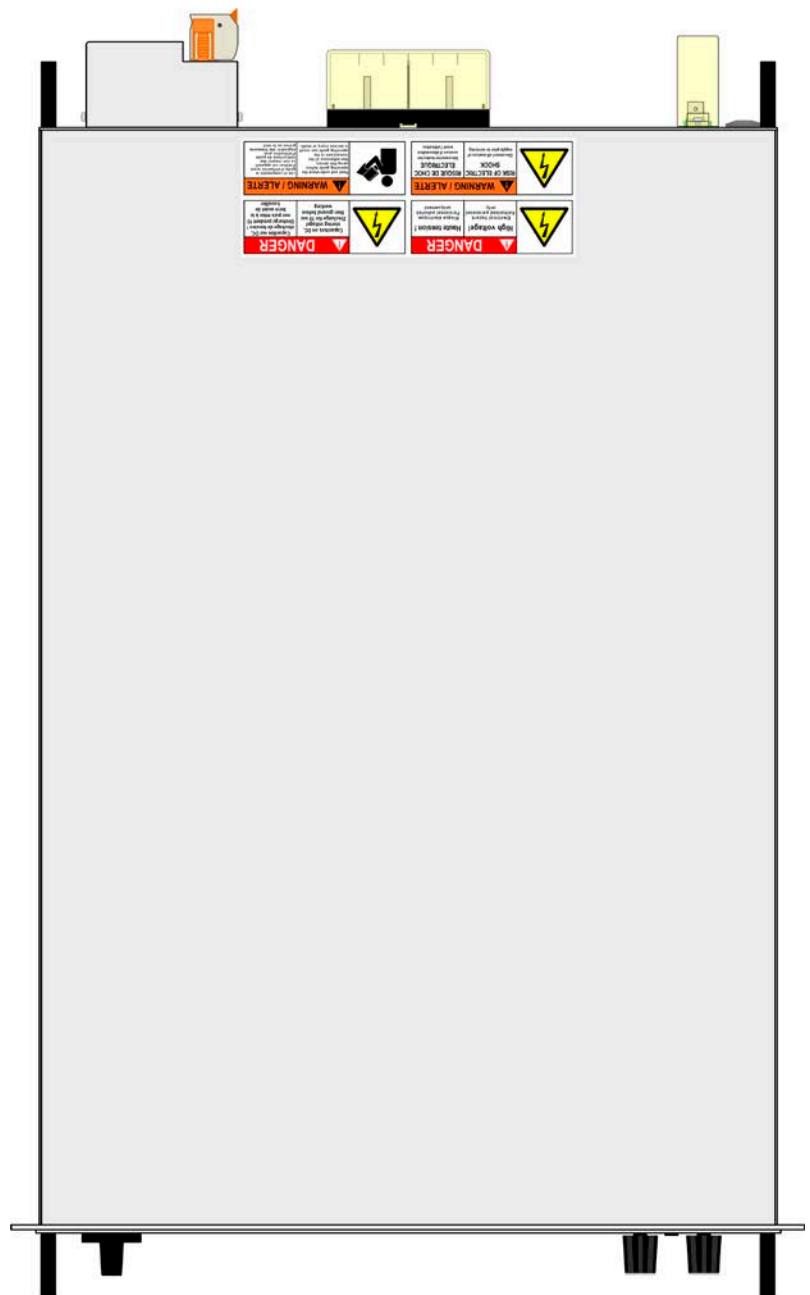
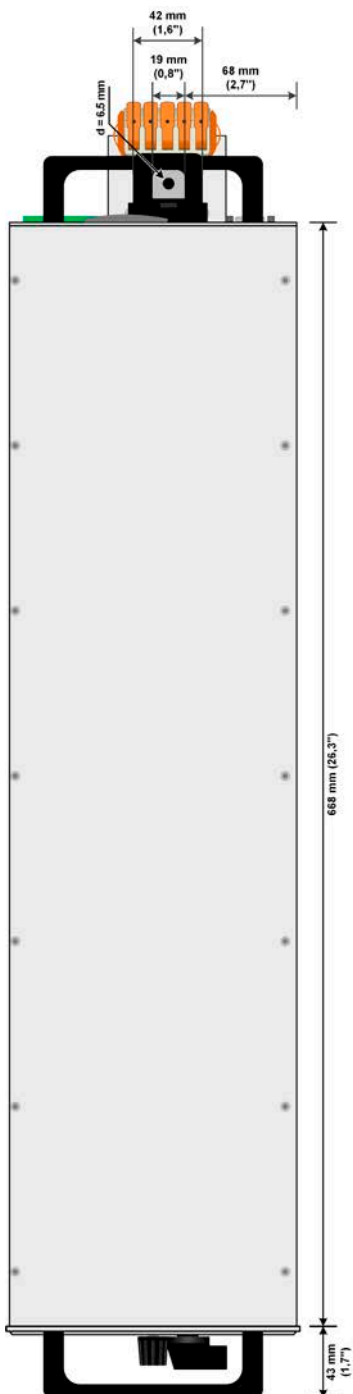
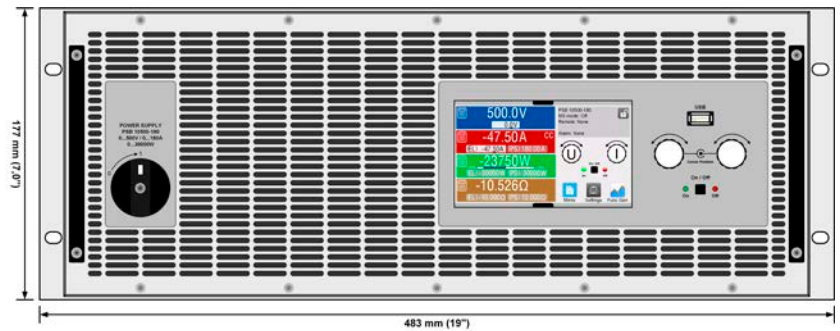

1.8.4.5 Front panel description PSB 10000 4U

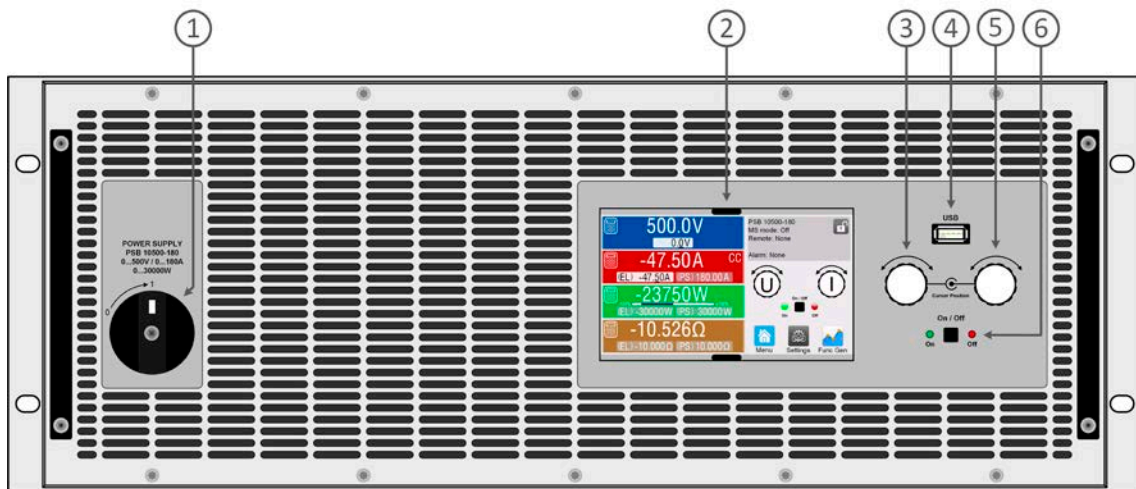

1. Power switch
2. TFT control interface, interactive operation and display
3. Rotary knob with push-button action, for settings and control
4. USB host, uses USB sticks for data logging and sequencing
5. Rotary knob with push-button action, for settings and control
6. On / Off push-button with LED status display

1.8.4.6 Rear panel description PSB 10000 4U ≥ 360 V

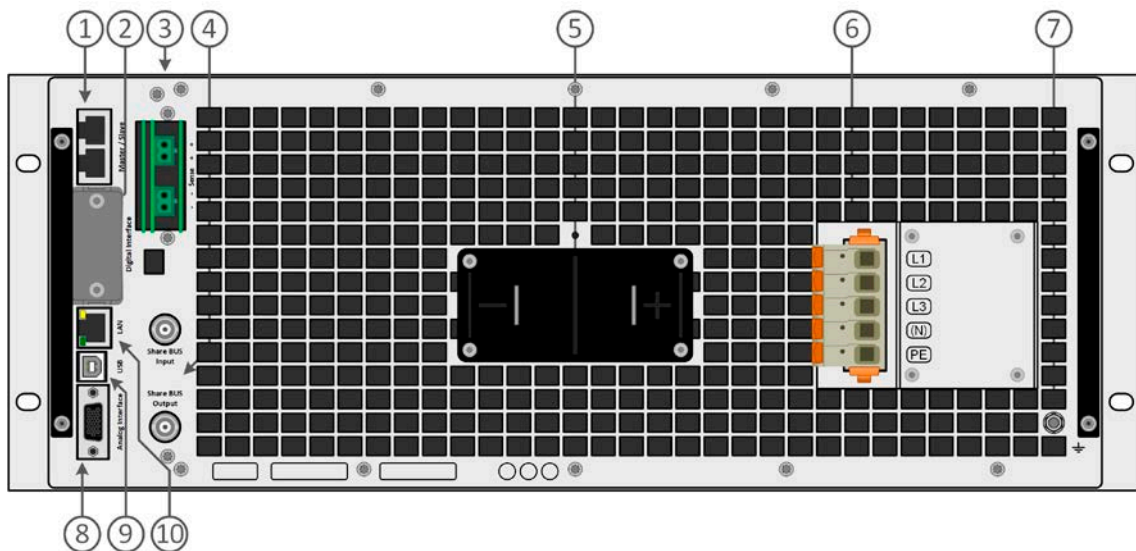

1. Master-Slave bus connectors to set up a system for parallel connection
2. Slot for interfaces
3. Remote sense connectors
4. Share bus connectors to set up a system for parallel connection
5. DC output connector (copper blades)
6. AC input connector
7. Grounding connection screw (PE)
8. Connector (DB15 female) for isolated analog programming, monitoring and other functions
9. USB interface
10. Ethernet interface

1.8.4.7 Front panel description PSB 10000 4U with Water Cooling option

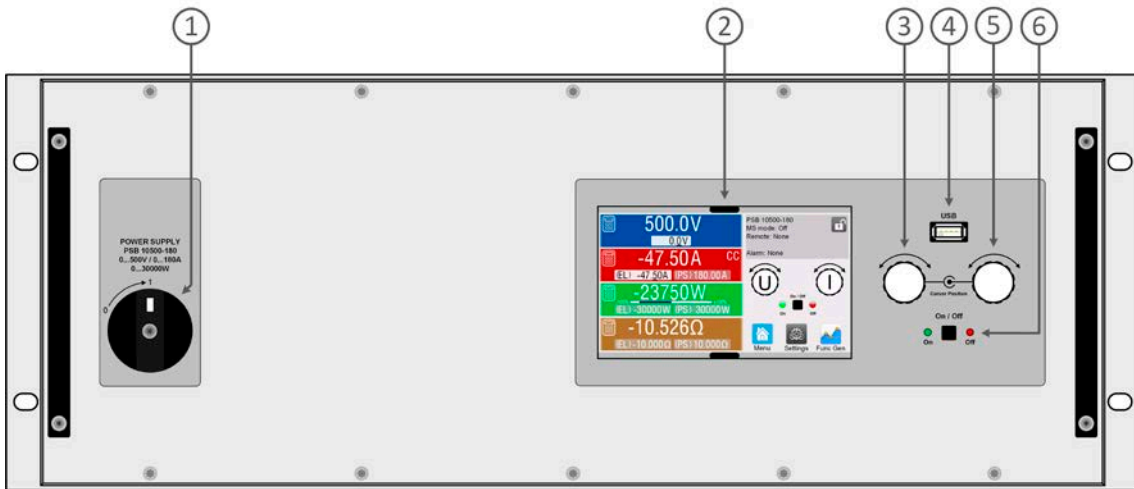

1. Power switch
2. TFT control interface, interactive operation and display
3. Rotary knob with push-button action, for settings and control
4. USB host, uses USB sticks for data logging and sequencing
5. Rotary knob with push-button action, for settings and control
6. On / Off push-button with LED status display

1.8.4.8 Rear panel description PSB 10000 4U with Water Cooling option

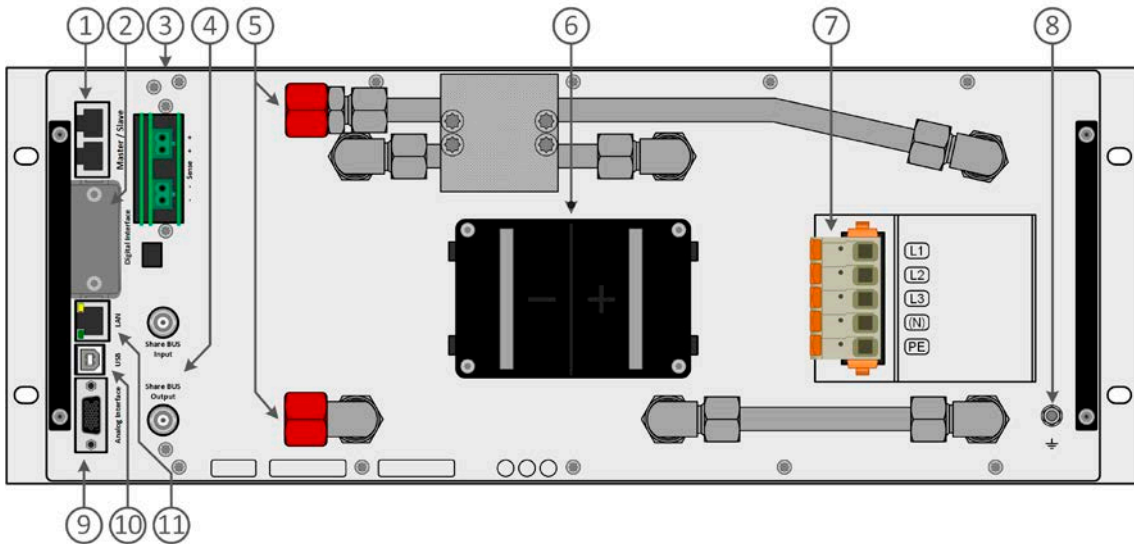

1. Master-Slave bus connectors to set up a system for parallel connection
2. Slot for interfaces
3. Remote sense connectors
4. Share bus connectors to set up a system for parallel connection
5. Inlets and outlets for water-cooling
6. DC output terminal (copper blades)
7. AC input connector
8. Grounding connection screw (PE)
9. Connector (DB15 female) for isolated analog programming, monitoring and other functions
10. USB interface
11. Ethernet interface

1.8.5 Control elements

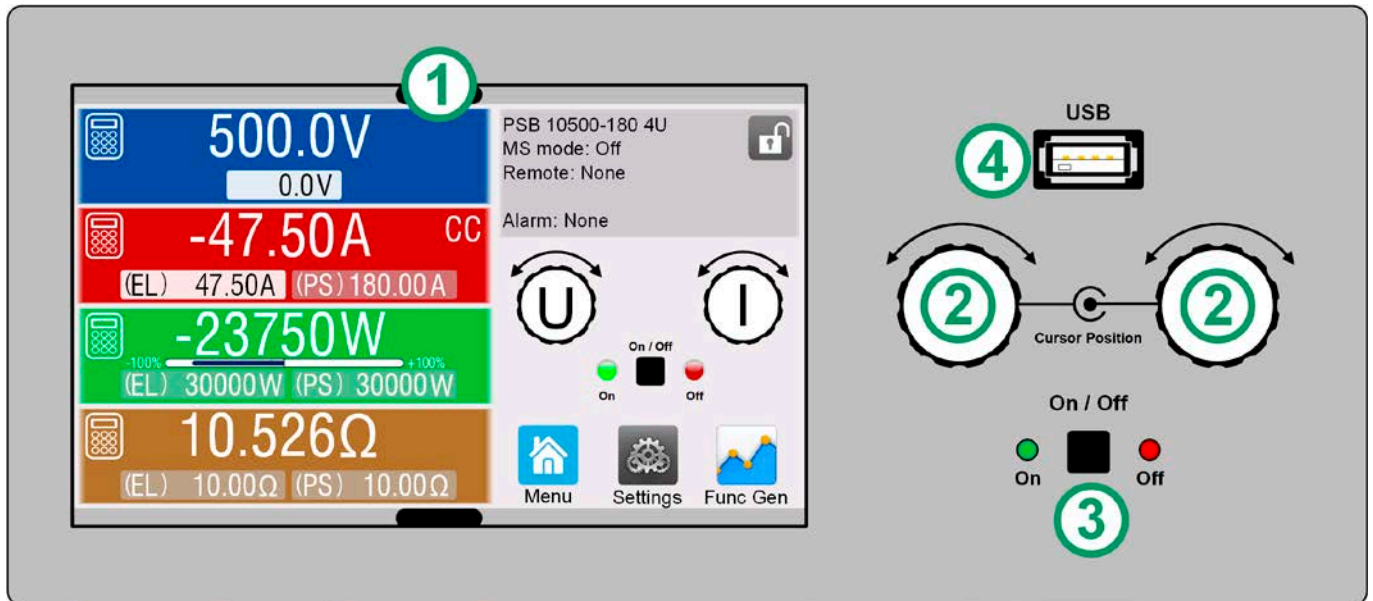

Figure 1- Control Panel

Overview of the elements on the control panel

For a detailed description see section "1.9.6. The control panel (HMI)".

(1)	Touchscreen display Used for selection and adjustment of set values, call of menus, as well as display of actual values and status. The touchscreen can be operated with the fingers or with a stylus.
(2)	Rotary knob with push button function Left knob (turn): voltage set value adjustment Left knob (push): shift the decimal position (cursor) of the voltage set value Right knob (turn): current, power or resistance set value adjustment Right knob (push): shift the decimal position (cursor) of the currently assigned value
(3)	On/Off Button for DC terminal Used to toggle the DC terminal between on and off, also used to start a function run. The LEDs "On" and "Off" indicate the state of the DC terminal, no matter if the device is manually controlled or remotely.
(4)	Port for USB sticks For the connection of standard USB sticks. See section "1.9.6.5. USB port (front side)" for more details.

1.9 Construction and function

1.9.1 General description

The power supplies of the PSB 10000 4U series are so-called bidirectional devices, incorporating the function of a laboratory power supply (source) and an electronic load (sink) into one unit. They allow for easy setup of applications according to the source-sink principle with a minimum of required hardware and cabling. Switching between source and sink operation is seamless and without delay at zero point.

The sink feature furthermore includes an energy recovery function, same as the one in series ELR 10000, which inverts the consumed DC energy with an efficiency of up to 96% and feeds it back into the local mains.

Apart from basic functions of power supplies, set point curves can be generated by the integrated function generator (sine, rectangular, triangular and other curve types). Arbitrary generator curves (99 points) can be saved to and loaded from a USB stick. Some of the functions even offer to dynamically switch between source and sink operation mode by setting up positive (for the source) or negative (for the sink) current set values.

For remote control the devices are provided as standard with USB and Ethernet ports on the rear side, as well as a galvanically isolated analog interface. Via optional plug-in interface modules, another digital interface such as for RS232, Profibus, ProfiNet, ModBus TCP, CAN, CANopen or EtherCAT can be added. These enable the devices to be connected to standard industrial buses simply by changing or adding a small module. The configuration, if necessary at all, is simple.

In addition, the devices offer as standard the possibility for parallel connection in so-called Share bus operation for constant current sharing, plus a true master-slave connection with totaling of all actual values is also provided as standard. Operating in this way allows for up to 64 units to be combined to a single system with a total power of up to 1920 kW.

Alternatively to the air-cooled versions there are also water-cooled version available which are usually configured and offered in cabinet systems with a complete water cooling distribution inside. For DIY water-cooled systems single units can also be obtained upon request.

1.9.2 Block diagram

The block diagram illustrates the main components inside the device and their relationships.

There are digital, microprocessor controlled components (KE, DR, HMI), which can be target of firmware updates.

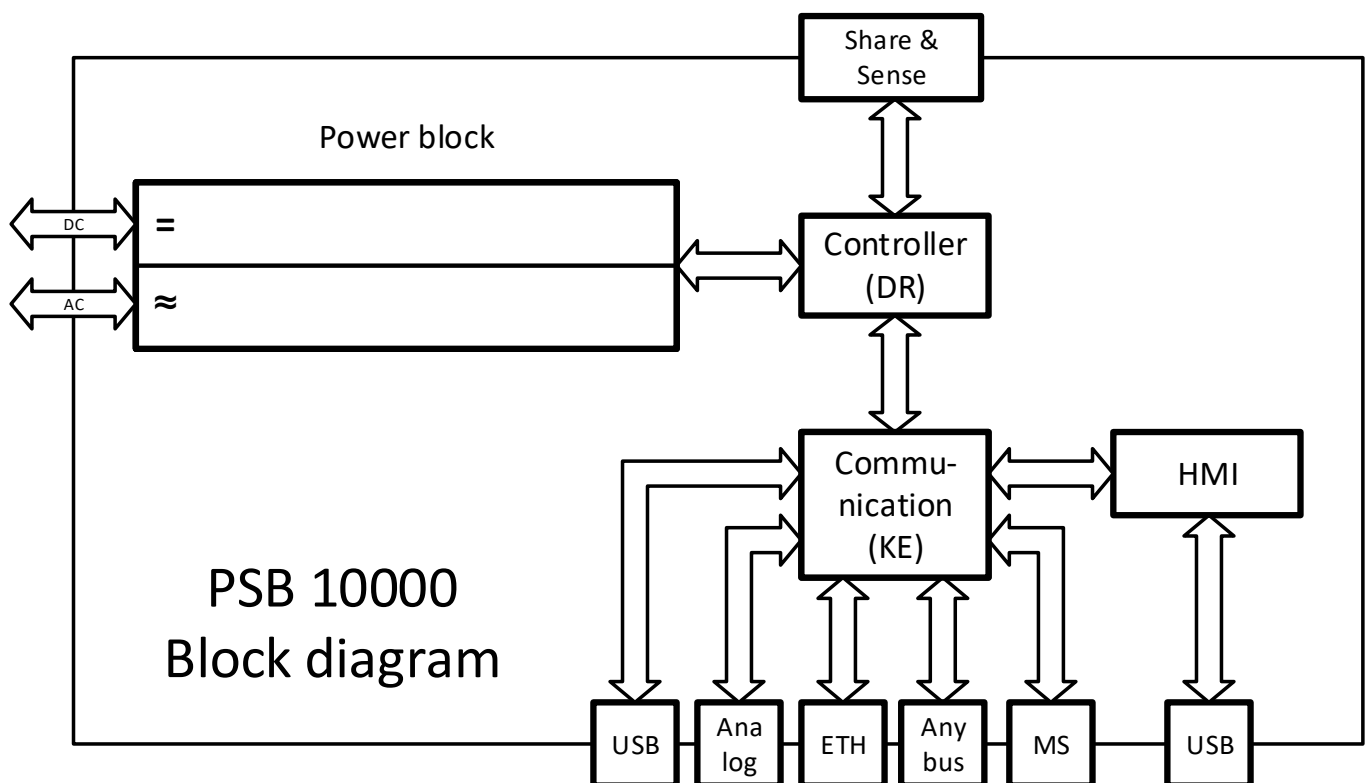

1.9.3 Scope of delivery

- 1 x Bidirectional power supply device
- 2 x Remote sensing plugs
- 1 x 1.8 m (5.9 ft) USB cable
- 1 x Set of DC terminal covers
- 1 x Sense terminal cover
- 1 x USB stick with documentation and software
- 1 x AC connector plug (clamp type)
- 1 x Set for AC cable strain relief

1.9.4 Accessories

For all models in this series, with or without water cooling option installed, the following accessories are available:

IF-AB Interface modules	Pluggable and retrofittable, digital interface modules for RS232, CANopen, Profibus, ProfiNet, ModBus TCP, EtherCAT or CAN are available. Details about the interface modules and the programming of the device using those interfaces can be found in separate documentation. It's usually available on the USB stick, which is included with the device, or as PDF download on the manufacturers website.
EABS Battery simulation	EABS is short for EA Battery Simulator and is an optionally available, USB dongle licensed Windows software. In combination with the bidirectional power supplies of series PSB 9000, PSBE 9000, PSB 10000 and PSBE 10000 it simulates either a single lithium-ion cell or lead-acid battery or multiple in series and/or parallel connection. The simulation works with battery typical values such as capacity, temperature, state of charge, internal resistance and cell voltage, plus adjustable test conditions.

1.9.5 Options

These options are usually ordered along with the device, as they are permanently built in or preconfigured during the manufacturing process.

POWER RACKS 19" rack	Racks in various configurations up to 42U as parallel systems are available, or mixed with electronic load devices to create test systems. Further information in our product catalogue, on our website or upon request
WC Water cooling	Replaces the standard cooling blocks of the internal power stages by three interconnected, water cooled blocks with two taps led out for supply. This options helps to avoid heating up the environment due to exhausted heat caused by a certain power dissipation when the device or a cabinet full of units runs as source. As a side effect, this type of cooling also reduces audible noise.

1.9.6 The control panel (HMI)

The HMI (**H**uman **M**achine **I**nterface) consists of a display with touchscreen, two rotary knobs, a pushbutton and a USB port.

1.9.6.1 Touchscreen display

The graphic touchscreen display is divided into a number of areas. The complete display is touch sensitive and can be operated by finger or stylus to control the equipment.

In normal operation the left hand side is used to show actual values and set values and the right hand side is used to display status information:

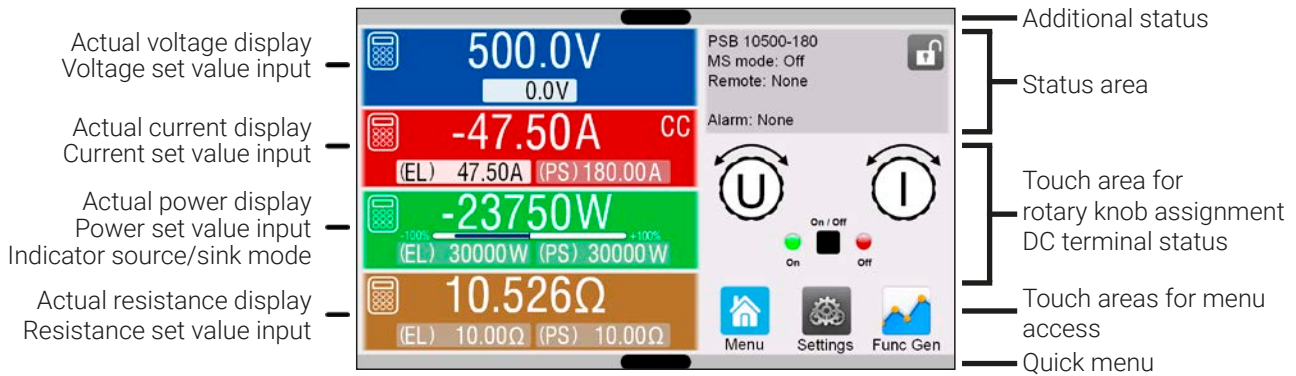

Touch areas may be enabled or disabled:



Black text = Enabled



Grey text = Touch area temporarily disabled

This applies to all touch areas. Some can additionally show a small padlock sign, indicating that the feature is permanently locked, usually due to a specific setting.

• Actual / set values area (left hand side)

In normal operation the actual values (large numbers) and set values (small numbers) for voltage, current, power and resistance on the DC terminal are displayed. For the two operation modes, sink (displayed as **EL**) and source (displayed as **PS**), there are two separate set values each for current, power and resistance. The two resistance set values are only displayed while resistance mode is active, while an actual resistance is only displayed during sink mode operation.

The actual values of current and power can be negative (signed) or positive (unsigned). A negative value belongs to sink mode and indicates that the device is working as electronic load.

When the DC terminal is switched on the actual regulation mode is displayed as **CV**, **CC**, **CP** or **CR**, next to the corresponding actual value, as shown in the figure above.

The set values can be adjusted with the rotary knobs next to the display screen or can be entered directly via the touchscreen. When adjusting with the knobs, pushing the knob will select the digit to be changed. Logically, the values are increased by clockwise turning and decreased by anti-clockwise turning.





General display and setting ranges:

Display	Unit	Range	Description
Actual voltage	V	0.2-125% U_{Nom}	Actual value of the voltage on the DC terminal
Set value of voltage	V	0-102% U_{Nom}	Set value for limiting the DC voltage
Actual current	A	0.2-125% I_{Nom}	Actual value of the current on the DC terminal
Set values of current	A	0-102% I_{Nom}	Set value for limiting the DC current
Actual power	W, kW	0.2-125% P_{Nom}	Actual value of power according to $P = U * I$
Set values of power	W, kW	0-102% P_{Nom}	Set value for limiting DC power
Actual resistance	Ω	$x^{(1-99999} / \infty$	Actual value of the internal resistance
Set value of resistance	Ω	$x^{(1-102\%} R_{Max}$	Set value for the internal resistance
Adjustment limits	ditto	0-102% nom	U-max, I-min etc., related to the physical quantities
Protection settings	ditto	0-110% nom	OVP, OCP, OPP (related to U, I and P)

⁽¹⁾ Lower limit for resistance set value varies. See tables in section 1.8.3

• **Status display (upper right)**

This area displays various status texts and symbols:

Display	Description
	The HMI is locked
	The HMI is unlocked
Remote:	The device is under remote control from....
Analog	...the built-in analog interface
ETH	...the built-in Ethernet interface
USB & others	...the built-in USB port or a plug in interface module
Local	The device has been locked by the user explicitly against remote control
Alarm:	Alarm condition which has not been acknowledged or still exists.
Event:	A user defined event has occurred which is not yet acknowledged.
MS mode: Master (n SI)	Master-slave mode activated, device is master of n slaves
MS mode: Slave	Master-slave mode activated, device is slave
FG:	Function generator activated, function loaded (only in remote control)
 / 	Data logging to USB stick active or failed

• **Area for assigning the rotary knobs and DC terminal status**

The two rotary knobs next to the display screen can be assigned to various functions. This area shows the actual assignments. These can be changed by tapping this area, as long as the panel is not locked.

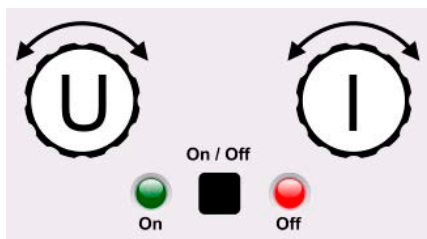

The physical quantities on the depiction of the knob show the current assignment. The left knob is always assigned to the voltage (U), while the right knob can be switched by tapping on the depiction. Furthermore, the DC terminal status is indicated by two LEDs (green = on).

There are following possible rotary knob assignments:

U I
 Left rotary knob: voltage
 Right rotary knob: current

U P
 Left rotary knob: voltage
 Right rotary knob: power

U R
 Left rotary knob: voltage
 Right rotary knob: resistance
 (only with R mode active)

Due to the device having two set values each for current, power and resistance, tapping multiple times will cycle through the 4 resp. 6 assignable set values for this knob. The currently not selected set values can't be adjusted via the rotary knob, unless the assignment is changed.

Alternatively to tapping on the knob depiction, the assignment can also be changed by tapping the colored set value areas.

However, values can be entered directly with a ten-key pad by tapping on the small icon . **This method of entering values allows for big set value steps.**

1.9.6.2 Rotary knobs

 As long as the device is in manual operation, the two rotary knobs are used to adjust set values in the main screen. For a detailed description of the individual functions see section "3.5. Manual operation".

1.9.6.3 Pushbutton function of the knobs

The rotary knobs also have a pushbutton function which is used in all value adjustment to move the cursor by rotation like this:

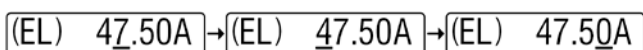

1.9.6.4 Resolution of the displayed values

In the display, set values can be adjusted in fixed increments. The number of decimal places depends on the device model. The values have 4 or 5 digits. Actual and set values always have the same number of digits.

Adjustment resolution and number of digits of set values in the display:

Voltage, OVP, UVD, OVD, U-min, U-max			Current, OCP, UCD, OCD, I-min, I-max			Power, OPP, OPD, P-max			Resistance, R-max		
Nominal	Digits	Min., in- crement	Nominal*	Digits	Min., in- crement	Nominal*	Digits	Min., in- crement	Nominal	Digits	Min., in- crement
≤80 V	4	0.01 V	<100 A	4	0.01 A	10000 W	5	1 W	<10 Ω	5	0.0001 Ω
200 V	5	0.01 V	>100 A	4	0.1 A	30000 W	5	1 W	≥10 Ω ... <100 Ω	5	0.001 Ω
360 V	4	0.1 V	≥1000 A	5	0.1 A	MS <100 kW	4	0.01 kW	≥100 Ω ... <1000 Ω	5	0.01 Ω
500 V	4	0.1 V	MS ≥3000 A	4	1 A	MS >100 kW	4	0.1 kW	>1000 Ω	5	0.1 Ω
750/920 V	4	0.1 V	MS >10000 A	5	1 A	MS >1000 kW	4	1 kW			
≥1000 V	5	0.1 V									

* MS = Master-slave

1.9.6.5 USB port (front side)

The frontal USB port, located above of the rotary knobs, is intended for the connection of standard USB sticks and can be used for loading or saving sequences for the arbitrary and the XY generator, as well as for recording measured data during running operation.

USB 2.0 and 3.0 sticks are well supported. The stick must be **FAT32** formatted. All supported files must be held in a designated folder in the root path of the USB stick in order to be found. This folder must be named **HMI_FILES**, such that a PC would recognize the path G:\HMI_FILES if the drive were to be assigned the letter G. Subfolders are supported. In case there are multiple files of the same type, e. g. such starting with "wave", the device will list the 20 first it can find.

The control panel of the device can read the following file types and names from a stick:

File name	Description	Section
wave_u<arbitrary_text>.csv wave_i<arbitrary_text>.csv	Function generator for an arbitrary function on voltage (U) or current (I) The name must begin with wave_u / wave_i , the rest is user defined.	3.11.10.1
profile_<arbitrary_text>.csv	Previously saved user profile. A max. of 10 files to select from is shown when loading a user profile.	3.10
mpp_curve_<arbitrary_text>.csv	User-defined curve data (100 voltage values) for mode MPP4 of the MPPT function	3.11.17.5
psb_pv<arbitrary_text>.csv psb_fc<arbitrary_text>.csv	PV or FC table for the XY function generator. The name must begin with psb_pv or psb_fc , the rest can be user defined.	3.11.13 3.11.14
pv_day_et_<arbitrary_text>.csv pv_day_ui_<arbitrary_text>.csv	Day trend data file to load for the simulation modes DAY I/T and DAY U/I of the extended PV function.	3.11.15.5
iu<arbitrary_text>.csv	IU table for the XY function generator. The name must begin with iu , the rest can be user defined.	3.11.12

The control panel of the device can save the following file types and names to a USB stick:

File name	Description	Section
usb_log_<nr>.csv	File with log data recorded during normal operation in all modes. The file layout is identical to the those generated from the Logging feature in EA Power Control. The <nr> field in the file name is automatically counted up if equally named files already exist in the folder.	3.5.8
profile_<nr>.csv	Saved user profile. The number in the file name is a counter and not related to the actual user profile number in the HMI. A max. of 10 files to select from is shown when loading a user profile.	3.10
wave_u<nr>.csv wave_i<nr>.csv	Sequence point data (here: sequences) of either voltage U or current I from arbitrary function generator	3.11.10.1

File name	Description	Section
battery_test_log_<nr>.csv	File with log data recorded from the battery test function. For a battery test log, data different and/or additional to log data of normal USB logging is recorded.	3.11.16.7
mpp_result_<nr>.csv	Result data from MPP tracking mode 4 in form of a table with 100 data groups (Umpp, Impp, Pmpp)	3.11.17.6
psb_pv<nr>.csv	PF function table data, as calculated by the device. Can be loaded again.	3.11.13
psb_fc<nr>.csv	FC function table data, as calculated by the device. Can be loaded again.	3.11.14
pv_record_<nr>.csv	Data from the data recording option in the extended PV function according to EN 50530.	3.11.15.7

1.9.7 USB port (rear side)

The USB port on the rear side of the device is provided for communication with the device and for firmware updates. The included USB cable can be used to connect the device to a PC (USB 2.0 or 3.0). The driver is delivered with the device and installs a virtual COM port. Details about remote control can be found in form of a programming guide on the included USB stick or on the web site of the manufacturer.

The device can be addressed via this port either using the international standard Mod-Bus RTU protocol or by SCPI language. The device recognizes the message protocol used automatically.

If remote control is in operation the USB port has no priority over either the interface module (see below) or the analog interface and can, therefore, only be used alternatively to these. However, monitoring is always available.

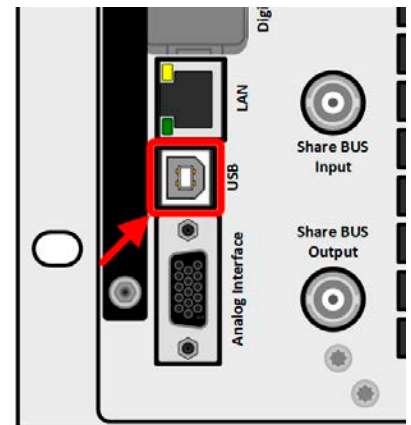

Figure 2 - USB port

1.9.8 Interface module slot

This slot on the rear side of the device is can receive various modules of the IF-AB interface series. The following options are available:

Article number	Name	Description
35400100	IF-AB-CANO	CANopen, 1x DB9, male
35400101	IF-AB-RS232	RS 232, 1x DB9, male (null modem)
35400103	IF-AB-PBUS	Profibus DP-V1 Slave, 1x DB9, female
35400104	IF-AB-ETH1P	Ethernet, 1x RJ45
35400105	IF-AB-PNET1P	ProfiNET IO, 1x RJ45
35400107	IF-AB-MBUS1P	ModBus TCP, 1x RJ45
35400108	IF-AB-ETH2P	Ethernet, 2x RJ45
35400109	IF-AB-MBUS2P	ModBus TCP, 2x RJ45
35400110	IF-AB-PNET2P	ProfiNET IO, 2x RJ45
35400111	IF-AB-CAN	CAN 2.0 A / 2.0 B, 1x DB9, male
35400112	IF-AB-ECT	EtherCAT, 1x RJ45

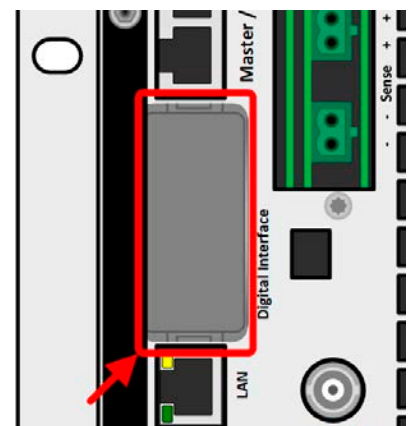

Figure 3 - Interface slot

The modules can be installed by the user and hence retrofitted without problem. A firmware update of the device may be necessary in order to recognize and support certain modules.



Switch your device off before adding or removing modules!

1.9.9 Analog interface

This 15 pole D-sub socket on the rear side of the device is provided for remote control of the device via analog or digital signals.

If remote control is in operation this analog interface can only be used alternately to the digital interface. However, monitoring is always available.

The input voltage range of the set values and the output voltage range of the monitor values, as well as reference voltage level can be switched in the settings menu of the device between 0-5 V and 0-10 V, in each case for 0-100%.

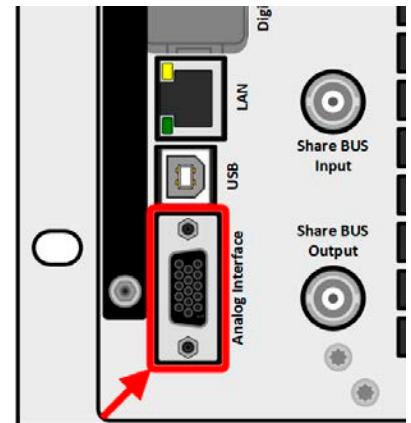

Figure 4 - Analog interface

1.9.10 "Share BUS" connector

The two BNC sockets (50 Ω type) labeled "Share BUS" form a digital, passed-through Share bus. This bus is bidirectional and connects the bus master unit via "Share BUS Output" to the next slave unit ("Share BUS Input") etc., for use in parallel operation (master-slave). BNC cables of suitable length can be obtained from us or electronics stores.

Basically, all 10000 series are compatible on this Share bus, though only connection of the same device type, i. e. power supply with power supply or electronic load with electronic load is supported by the devices for master-slave.

For a PSB 10000 series device, different or identical PSB 10000 series models can be used as slave units. A PSB 10000 device can furthermore be the master of PSBE 10000 devices.

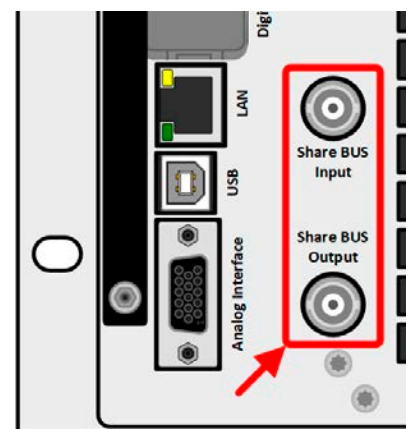

Figure 5 - Share bus

1.9.11 "Sense" connector (remote sensing)

In order to compensate for voltage drops along the DC cables to the load or external source, the Sense input (2 plugs included in delivery, one each for positive and negative pole) can be connected to the load resp. external source. The maximum possible compensation is given in the technical specifications.



In a master-slave system it's intended to wire remote sensing only to the master which would then forward the compensation to the slaves via Share BUS.



The Sense cover must be installed during operation, because there can be hazardous voltage on the sense lines! Reconfiguration on the Sense connectors is only permissible if the device is disconnected from AC supply and all DC sources!

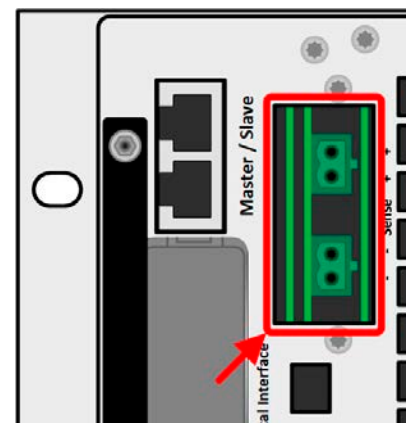

Figure 6 - Remote sensing connectors

1.9.12 Master-Slave bus

There is a further set of connectors on the rear side of the device, comprising two RJ45 sockets, which enables multiple compatible devices to be connected via a digital bus (RS485) in order to create a master-slave system. Connection is made using standard CAT5 cables.

It's recommended to keep the connections as short as possible and to terminate the bus if required. The termination is done via digital switches and activated in the device setup menu in group "Master-Slave".

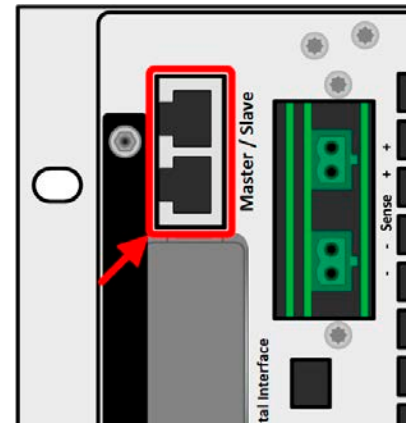

Figure 7 - Master slave bus ports

1.9.13 Ethernet port

The RJ45 LAN/Ethernet port on the rear side of the device is provided for communication with the device in terms of remote control or monitoring. The user has basically two options of access:

1. A website (HTTP, port 80) which is accessible in a standard browser via the IP or the host name given for the device. This website offers a configuration page for network parameters, as well as an input box for SCPI commands to control the device remotely by manually entering commands.

2. TCP/IP access via a freely selectable port (except 80 and other reserved ports). The standard port for this device is 5025. Via TCP/IP and the selected port, communication to the device can be established in most of the common programming languages.

Using this LAN port, the device can either be controlled by commands from SCPI or ModBus RTU protocol, while automatically detecting the type of message.

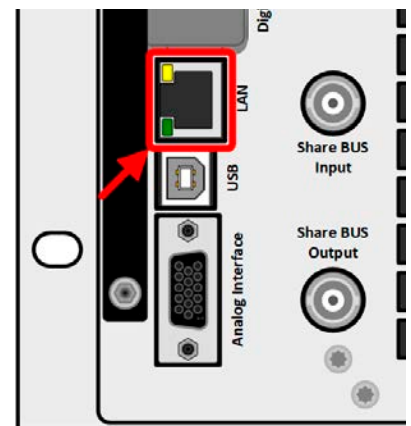

Figure 8- LAN port

Access via ModBus TCP protocol is only supported by the optionally and separately available ModBus TCP interface module. See "1.9.8. Interface module slot".

The network setup can be done manually or by DHCP. Transmission speed and duplex mode are on automatic mode.

If remote control is in operation the Ethernet port has no priority over any other interface and can, therefore, only be used alternatively to these. However, monitoring is always available.

1.9.14 Water cooling

Models with water cooling are optionally available as replacement of the default models with air-cooling. This option is built in during the manufacturing process, so retrofitting isn't possible. Cooling the device with water instead of air comes with a few advantages:

- Less ambient noise generated by the device
- Better cooling at higher ambient temperatures
- No direct dissipation of heat into the ambiance of the device

However, there also disadvantages:

- The device isn't allowed to run under load without active water flow
- Water flow inside an electronic device includes a higher risk of damage caused by a leak or by condensation of water from air humidity (bedewing)

The water taps are located on the rear side of the device, also see the rear view drawing in section 1.8.4. Details about the connection, requirements and use of the water cooling can be found in section 2.3.4.

2. Installation & commissioning

2.1 Transport and storage

2.1.1 Transport



- The handles on the front and rear side of the device are **not** for carrying!
- Because of its weight, transport by hand should be avoided where possible. If unavoidable then only the housing should be held and not on the exterior parts (handles, DC terminal, rotary knobs).
- Do not transport when switched on or connected!
- When relocating the equipment use of the original packing is recommended
- The device should always be carried and mounted horizontally
- Use suitable safety clothing, especially safety shoes, when carrying the equipment, as due to its weight a fall can have serious consequences.

2.1.2 Packaging

It's recommended to keep the complete transport packaging for the lifetime of the device for relocation or return to the manufacturer for repair. Otherwise the packaging should be disposed of in an environmentally friendly way.

2.1.3 Storage

In case of long term storage of the equipment it's recommended to use the original packaging or similar. Storage must be in dry rooms, if possible in sealed packaging, to avoid corrosion, especially internal, through humidity.

2.2 Unpacking and visual check

After every transport, with or without packaging, or before commissioning, the equipment should be visually inspected for damage and completeness using the delivery note and/or parts list (see section "1.9.3. Scope of delivery"). An obviously damaged device (e.g. loose parts inside, damage outside) must under no circumstances be put in operation.

2.3 Installation

2.3.1 Safety procedures before installation and use



- The device has a considerable weight. Therefore the proposed location of the equipment (table, cabinet, shelf, 19" rack) must be able to support the weight without restriction.
- When using a 19" rack, rails suitable for the width of the housing and the weight of the device are to be used (see "1.8. Technical Data")
- Before connecting to the mains ensure the supply voltage is as shown on the product label. Overvoltage on the AC supply can cause equipment damage.
- Devices of this series feature an energy recovery function which, similar to solar energy equipment, which feeds energy back into the local or public grid. Feedback into the public grid must not be operated without adherence of directives from the local energy supplying company and it must be investigated before the installation or latest before initial commission if there is requirement to install a grid protection device!

2.3.2 Preparation

2.3.2.1 Selecting cables

The required AC supply connection for these device is termination. It's done via the 5 pole AC connector on the rear (AC filter box). A matching plug is included. Wiring of the plug is at least 4 wire (3x L, PE) of suitable cross section and length. Full configuration with all phases plus N and PE is permissible.

For recommendations for a cable cross section see "2.3.5. Connection to AC supply". Dimensioning of the DC wiring to the load/consumer has to reflect the following:



- The cable cross section should always be specified for at least the maximum current of the device.
- Continuous operation at the approved limit generates heat which must be removed, as well as voltage loss which depends on cable length and heating. To compensate for these the cable cross section should be increased and the cable length reduced.

2.3.2.2 Additional measure for energy recovering devices

All models of this series are so-called recuperating devices, at least when they're working in sink mode. In this mode they feed back a specific amount of energy into the local or public grid. The devices can't work sink mode without this functionality. The goal is to consume the recovered energy completely in the local power grid of a company or plant. In case it can occur that more energy is recuperated than consumed, the excess will be fed back into the public grid which usually isn't allowed without further precautions.

The operator of the device must, owing to circumstances, contact the local electric utility and clarify what's allowed and if a so-called network & system protection is required to be installed. There are several different international provisions or standard, such as the german VDE-AR-N 4105/4110 or the british ENA EREC G99 which regulate this situation.

The device itself provides a basic protection and would shut down energy feed back in case it can't work, but a full protection against frequency shift or voltage deviation can only be accomplished by such an NS protection device, which will also prevent isolation operation.

We offer NS protection solutions. They already fulfill the german AR-N 4105 and 4410, as well as the italian CEI 0-21 or the british G59/G98/G99.

Concept of an NS protection system:

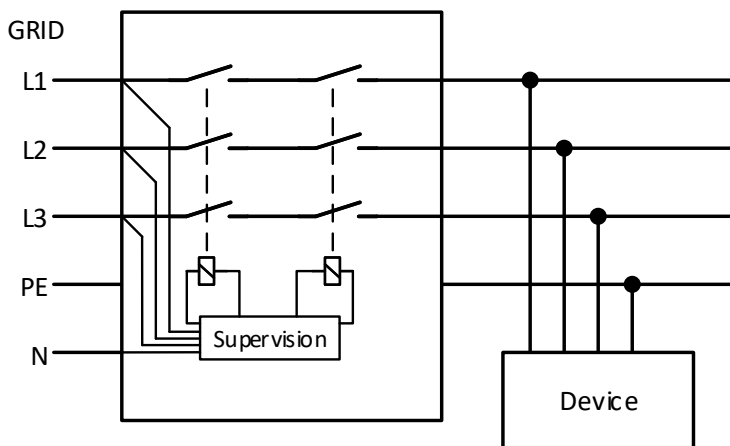
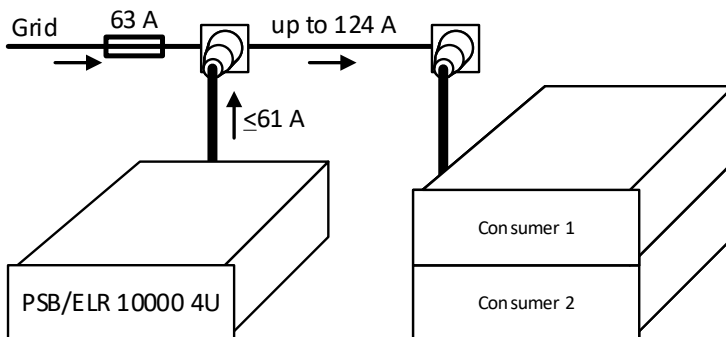

Figure 9 - Principle of an NS protection network

2.3.2.3 Installation concept for energy recovering devices

A PSB 10000 device recovers energy and feeds it back into the local power grid of a company or big electric plant. The recovered current adds to the grid current (see schematic below) and this can lead to an overload of the existing electric installation. Considering any two outlets, no matter of what type they are, there is usually no extra fusing installed in between. In case of a defect in the AC part (i.e. short-circuit) of any consumer device or when there are multiple devices connected which could take a higher power, the total current could flow across wires which are not laid out for this higher current. It could lead to damage or even fire in the wires or connection points.

In order to avoid damages and accidents, the existing installation concept must be taken into regard before installing such recovering devices. Schematic depiction with 1 recovering device and consumers:



When running a higher number of recovering, i. e. energy backfeeding units on the same leg of the installation, the total currents per phase increases accordingly.

2.3.3 Installing the device



- Select the location for the device so that the connection to the load resp. source is as short as possible.
- Leave sufficient space, at least 30 cm (1 ft), behind the equipment for ventilation (only required for the standard air-cooled version)
- The device must not be operated without a proper touch protection for the AC connection, which is either only accomplished by installation of the device in a 19" rack/cabinet with lockable doors or by applying further measures (additional cover etc.)

All models in this series require to be installed and operated in a closed appliance, such as a cabinet. It's also mandatory to install a rigid AC connection. Open operation on a desk or similar isn't permissible.

A device in a 19" chassis will usually be mounted on suitable rails and installed in 19" racks or cabinets. The depth of the device and its weight must be taken into account. The handles on the front are for sliding in and out of the cabinet. Slots on the front plate are provided for fixing the device (fixing screws not included).

The unacceptable positions, as shown below, are also valid for the vertical mount of the device onto a wall (room or inside a cabinet). The required air flow would be insufficient.

Acceptable and unacceptable installation positions (air or water cooled, air cooled shown):

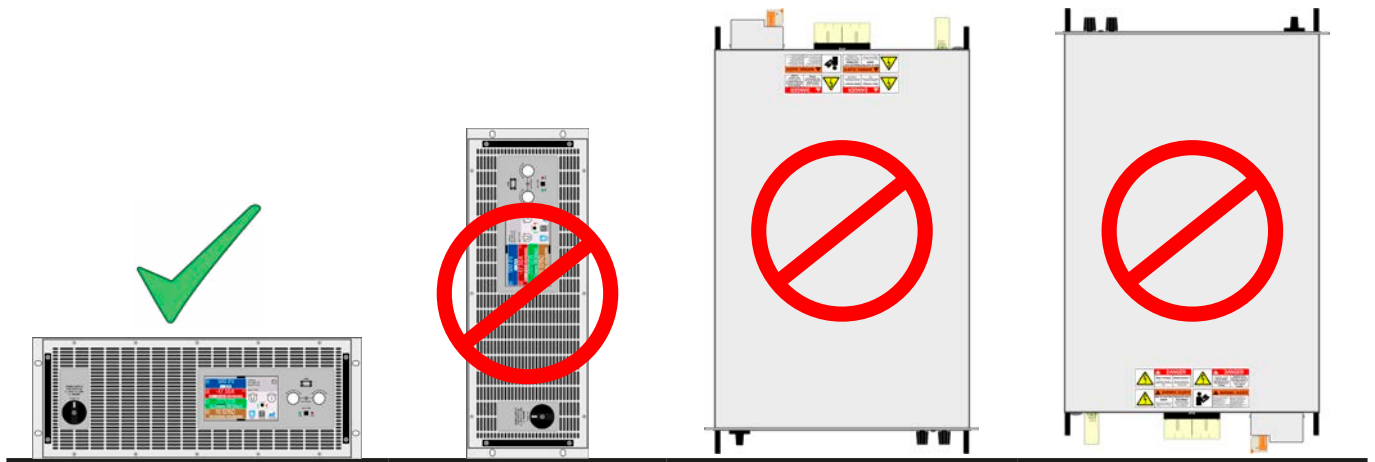

Standing surface

2.3.4 Connection to water supply (WC models)

If already available, the water supply should be connected and any further measures related to water cooling installation should be carried out before the AC supply for the device is connected, let alone the unit is powered. Correct installation and connection, test for **watertightness** and later operation lie in the sole responsibility of the operator or end user.

2.3.4.1 Requirements

The water pipe construction is identical with all models in this series but due to the rated current and hence different heat dissipation per minute in the internal cooling block, a model depending requirement to the water and the ambience must be met:

Model	10 V / 60 V / 80 V	200 V to 2000 V
Internal water flow:	Series	Series
Ambient temperature:	Max. +50 °C (122 °F)	Max. +50 °C (122 °F)
Water intake temperature (min):	See dew point tables below	See dew point tables below
Water intake temperature (max):	+33 °C (82 °F)	+26 °C (91 °F)
Flow rate:	Min. 12 l/minute (3.17 gal/minute)	Min. 7 l/minute (1.85 gal/minute)
Corrosion protection:	Ethylene glycol	Ethylene glycol
Water hardness:	Soft (calcium carbonate < 2 mmol/l)	Soft (calcium carbonate < 2 mmol/l)
Water pressure:	Min. 1 bar (14 psi), max. 4 bar (58 psi)	Min. 1 bar (14 psi), max. 4 bar (58 psi)

2.3.4.2 Connection point

The device has three separate cooling blocks internally, each with its own water pipe. All pipes are led out and connected outside of the device. The water will thus flow through all three pipes in parallel. On the rear of the device are two taps (tee pieces) for water connection:

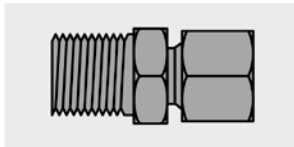

Tap: angle piece
Thread: M16x1.5

Which one of the two taps is used for intake and outlet is arbitrary. For later use it's only important to have a sufficient amount of water flowing through the pipes, along with a certain water intake temperature.

The hose connection is either directly done on the tee or end piece, using the metric thread, or by using a hose tail swivel, for example one from company Schwer Fittings, type SA-DKL90. This swivel is already sealing upon mount, using a 24° metal cone.

2.3.4.3 Operation and supervision

Once the water cooling is installed and running, there is one primary value left to supervise permanently, the so-called dew point. Depending on the temperature of water on the intake in combination with the humidity of ambient air and also the air inside the device water can condensate, i. e. dew inside the device. This must be avoided under all circumstances! It means, it might be required to have regulated water cooling system in order to react to varying ambient conditions.

The dew point is defined in several norms, for instance DIN 4108. The table below defines the dew point (air humidity to water) **in °C in the upper table** and **in °F in the lower table** at specific ambient temperatures and air humidity levels. The intake water temperature must always be higher than the dew point:

Ambient	Relative air humidity in per cent										
	45%	50%	55%	60%	65%	70%	75%	80%	85%	90%	95%
14°C	2.2	3.76	5.1	6.4	7.58	8.67	9.7	10.71	11.64	12.55	13.36
15°C	3.12	4.65	6.07	7.36	8.52	9.63	10.7	11.69	12.62	13.52	14.42
16°C	4.07	5.59	6.98	8.29	9.47	10.61	11.68	12.66	13.63	14.58	15.54
17°C	5	6.48	7.92	9.18	10.39	11.48	12.54	13.57	14.5	15.36	16.19
18°C	5.9	7.43	8.83	10.12	11.33	12.44	13.48	14.56	15.41	16.31	17.25
19°C	6.8	8.33	9.75	11.09	12.26	13.37	14.49	15.47	16.4	17.37	18.22
20°C	7.73	9.3	10.72	12	13.22	14.4	15.48	16.46	17.44	18.36	19.18
21°C	8.6	10.22	11.59	12.92	14.21	15.36	16.4	17.44	18.41	19.27	20.19
22°C	9.54	11.16	12.52	13.89	15.19	16.27	17.41	18.42	19.39	20.28	21.22
23°C	10.44	12.02	13.47	14.87	16.04	17.29	18.37	19.37	20.37	21.34	22.23
24°C	11.34	12.93	14.44	15.73	17.06	18.21	19.22	20.33	21.37	22.32	23.18
25°C	12.2	13.83	15.37	16.69	17.99	19.11	20.24	21.35	22.27	23.3	24.22
26°C	13.15	14.84	16.26	17.67	18.9	20.09	21.29	22.32	23.32	24.31	25.16
27°C	14.08	15.68	17.24	18.57	19.83	21.11	22.23	23.31	24.32	25.22	26.1

Ambient	Relative air humidity in per cent										
	45%	50%	55%	60%	65%	70%	75%	80%	85%	90%	95%
28°C	14.96	16.61	18.14	19.38	20.86	22.07	23.18	24.28	25.25	26.2	27.18
29°C	15.85	17.58	19.04	20.48	21.83	22.97	24.2	25.23	26.21	27.26	28.18
30°C	16.79	18.44	19.96	21.44	23.71	23.94	25.11	26.1	27.21	28.19	29.09
32°C	18.62	20.28	21.9	23.26	24.65	25.79	27.08	28.24	29.23	30.16	31.17
34°C	20.42	22.19	23.77	25.19	26.54	27.85	28.94	30.09	31.19	32.13	33.11
36°C	22.23	24.08	25.5	27	28.41	29.65	30.88	31.97	33.05	34.23	35.06
38°C	23.97	25.74	27.44	28.87	30.31	31.62	32.78	33.96	35.01	36.05	37.03
40°C	25.79	27.66	29.22	30.81	32.16	33.48	34.69	35.86	36.98	38.05	39.11
45°C	30.29	32.17	33.86	35.38	36.85	38.24	39.54	40.74	41.87	42.97	44.03
50°C	34.76	36.63	38.46	40.09	41.58	42.99	44.33	45.55	46.75	47.9	48.98

Ambient	Relative air humidity in per cent										
	45%	50%	55%	60%	65%	70%	75%	80%	85%	90%	95%
58°F	36	38.8	41.2	43.6	45.7	47.7	49.5	51.3	53	54.6	56.1
59°F	37.7	40.4	43	45.3	47.4	49.4	51.3	53.1	54.8	56.4	58
61°F	39.4	42.1	44.6	47	49.1	51.1	53.1	54.8	56.6	58.3	60
63°F	41	43.7	46.3	48.6	50.8	52.7	54.6	56.5	58.1	59.7	61.2
65°F	42.7	45.4	47.9	50.3	52.4	54.4	56.3	58.3	59.8	61.4	63.1
67°F	44.3	47	49.6	52	54.1	56.1	58.1	59.9	61.6	63.3	64.8
68°F	46	48.8	51.3	53.6	55.8	58	59.9	61.7	63.4	65.1	66.6
70°F	47.5	50.4	52.9	55.3	57.6	59.7	61.6	63.4	65.2	66.7	68.4
72°F	49.2	52.1	54.6	57.1	59.4	61.3	63.4	65.2	67	68.6	70.2
74°F	50.8	53.7	56.3	58.8	60.9	63.2	65.1	66.9	68.7	70.5	72.1
76°F	52.5	55.3	58	60.4	62.8	64.8	66.6	68.6	70.5	72.2	73.8
77°F	54	56.9	59.7	62.1	64.4	66.4	68.5	70.5	72.1	74	75.6
79°F	55.7	58.8	61.3	63.9	66.1	68.2	70.4	72.2	74	75.8	77.3
81°F	57.4	60.3	63.1	65.5	67.7	70	72.1	74	75.8	77.4	79
83°F	59	61.9	64.7	66.9	69.6	71.8	73.8	75.8	77.5	79.2	81
85°F	60.6	63.7	66.3	68.9	71.3	73.4	75.6	77.5	79.2	81.1	82.8
86°F	62.3	65.2	68	70.6	74.7	75.1	77.2	79	81	82.8	84.4
90°F	65.6	68.6	71.5	73.9	76.4	78.5	80.8	82.9	84.7	86.3	88.2
94°F	68.8	72	74.8	77.4	79.8	82.2	84.1	86.2	88.2	89.9	91.6
97°F	72.1	75.4	77.9	80.6	83.2	85.4	87.6	89.6	91.5	93.7	95.2
101°F	75.2	78.4	81.4	84	86.6	89	91.1	93.2	95.1	96.9	98.7
104°F	78.5	81.8	84.6	87.5	89.9	92.3	94.5	96.6	98.6	100.5	102.4
113°F	86.6	90	93	95.7	98.4	100.9	103.2	105.4	107.4	109.4	111.3
122°F	94.6	98	101.3	104.2	106.9	109.4	111.8	114	116.2	118.3	120.2

2.3.4.4 Notes

- The water flow should be started prior to powering the device, but at least prior to switching the DC terminal on

2.3.5 Connection to AC supply



- Connection to an AC supply must only be carried out by qualified personnel and the device must always be run directly on a power grid (transformer are permitted) and not on generators or UPS equipment!
- Cable cross section must be suitable for the maximum input current of the device! See tables below.
- According to standard EN 61010, the device must be fused externally and the fuse rating must be appropriate to the maximum AC current rating and AC cable cross section
- Ensure that all regulations for the operation of the device and connection to the public grid of energy recovering equipment have been considered and requirements have been met!
- WC models: For safety reasons it's recommended to install a 30 mA RCD for every water-cooled unit (option WC) or at least one per three units (due to the possible leak current, see technical data), in case multiple WC models run in parallel

All standard models in this series, as produced since approx. 01/2022, support to run either on 380/400/480 V or also 208 V (US and Japan grids). When running a model with 30 kW power rating on 208 V it would automatically switch into derated power mode in which the available DC power is decreased to 18 kW. This is detected every time when powering the device, so that the same model could provide the full 30 kW of rated power when being run on 380/400/480 V.

The so-called "US208V" models are special models which only run on 208 V supply and thus have a rigid rated power of 18 kW or 10 kW. They cannot operate on higher AC supply voltages.

2.3.5.1 AC supply requirements

No matter what particular variant the device is, standard, WC or Slave, the rated AC supply voltage on the type label is decisive. They all use a regular three-phase supply without N. Specification:

Rated DC power	Inputs on AC plug	Supply type	Configuration
10 kW / 30 kW	L1, L2, L3, (N), PE	Three-phase (3P)	Delta



The PE conductor is imperative and must always be wired to the AC plug!

2.3.5.2 Cross section

For the selection of a suitable cable **cross section** the rated AC current of the device and the cable length are decisive. Based on the connection of a **single unit** the table lists the maximum input current and recommended minimum cross section for each phase:

Available DC power	L1		L2		L3		PE ⁽¹⁾
	∅	I _{max}	∅	I _{max}	∅	I _{max}	∅
10 kW (rated)	≥10 mm ² (AWG8)	40 A	≥10 mm ² (AWG8)	40 A	≥10 mm ² (AWG8)	40 A	≥10 mm ² (AWG8)
18 kW (derated or US208V) at 208 V 30 kW (rated) at 380/400/480 V	≥10 mm ² (AWG8)	61 A	≥10 mm ² (AWG8)	61 A	≥10 mm ² (AWG8)	61 A	≥10 mm ² (AWG8)

2.3.5.3 AC plug & AC cable

The included connection plug can receive cable ends of up to 25 mm². The longer the connection cable, the higher the voltage loss due to the cable resistance. Therefore the mains cable should be kept as short as possible or have an even bigger cross section. Cables with 4 or 5 conductors can be used. When using a cable with N conductor, it's allowed to clamp it into the spare pin of the AC plug. Ratings of the AC plug:

- Max. cross section without cable end sleeve: 25 mm² (AWG4)
- Max. wire cross section with cable end sleeve: 16 mm² (AWG10)
- Stripping length without cable end sleeve: 18-20 mm (0.75 in)

¹ Valid for both, the ground conductor in the AC cable and the separate PE line for enclosure grounding

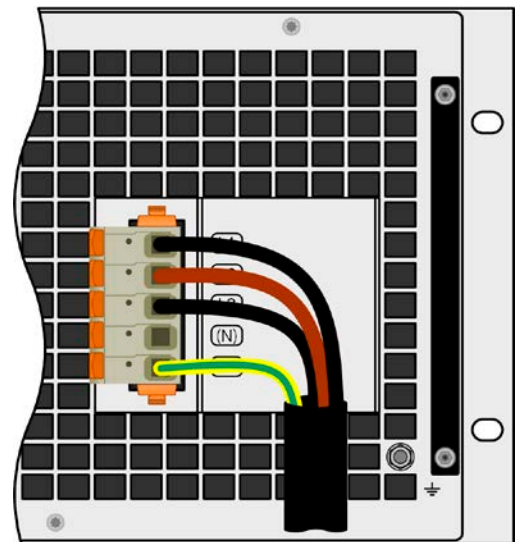
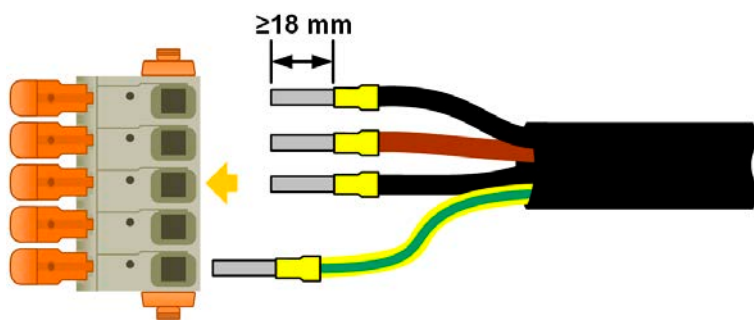

Figure 10 - Example for an AC cable with 4 conductors (european color code, cable not included in delivery)

2.3.5.4 Mounting the strain relief

All models in this series have a strain relief for the AC cable in their scope of delivery. It's recommended to be mounted and used by the installer, unless a different kind of strain relief is intended. Installation steps:

1. Remove the two screws from the AC filter box as marked in *Figure 11* below.
2. Place the bracket and fix it with the included, longer screws (M3x8) and spring/curved washers.
3. Plug the AC plug and lead the cable in front of the bracket, when seen from behind, and fix it with at least one, better both of the included cable ties.

The bracket and the cable ties can remain connected all the time. The AC plug has some space to be pulled if required. Should the device be removed from the installation (cabinet), it's recommended to only pull the plug and dismount the bracket.

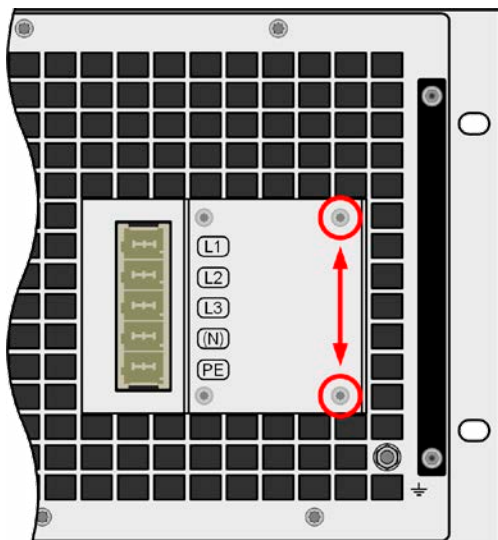

Figure 11 - Mounting position of the bracket

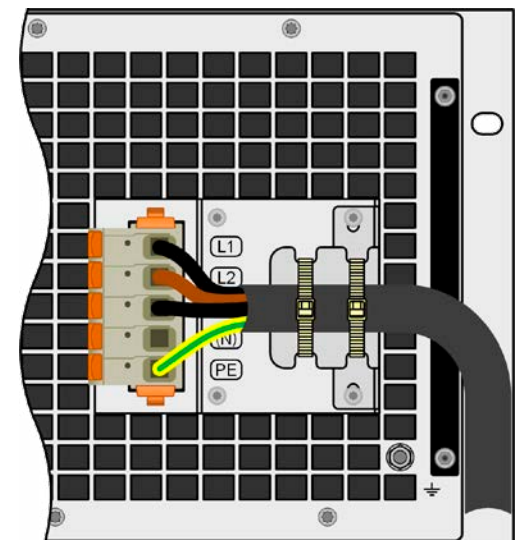

Figure 12 - Fully installed strain relief

2.3.5.5 Grounding the enclosure

From production date of approx. 01/2022, the devices feature a separate grounding point on the rear side, as depicted on the figure to the right and marked as item "7" or "8" in "1.8.4. Views".

For reasons of safety for people working with the device which, amongst other measures, is achieved by keeping the leakage current as low as possible, the enclosure can be grounded additionally to the standard grounding via the AC cable. It's done by laying a separate protective earth line (PE) of the same or higher cross section as in the AC cable and connected here.

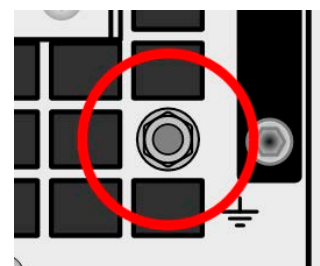

Figure 13 - Grounding point

2.3.6 Connection to DC loads or DC sources



- In the case of a device with a high nominal DC current and hence a thick and heavy DC connection cable it's necessary to take account of the weight of the cable and the strain imposed on the DC connection. Especially when mounted in a 19" cabinet or similar, where the cable could hang on the DC terminal, a strain reliever should be used.
- Besides the proper cross section of DC cables the proper electric strength (withstand voltage) of the cables must be considered.



No false polarity protection inside! When connecting sources with false polarity the device will be damaged, also when the device isn't powered!



When connected to DC, an external source charges the internal capacities on the DC terminal, even when the device isn't powered. Dangerous voltage levels can be present on the DC terminal, even after disconnection of that external source.

The DC terminal is located on the rear side of the device and is **not** protected by a fuse. The cross section of the connection cable is determined by the current consumption, cable length and ambient temperature.

For cables **up to 5 m (16.4 ft)** and average ambient temperature **up to 30°C (86°F)**, we recommend:

up to 40 A :	6 mm ² (AWG8)	up to 60 A :	16 mm ² (AWG4)
up to 80 A :	25 mm ² (AWG3)	up to 120 A :	35 mm ² (AWG1/0)
up to 180 A :	70 mm ² (AWG2/0)	up to 240 A :	2x 35 mm ² (AWG1/0)
up to 420 A :	2x 95 mm ² (AWG3/0)	up to 1000 A :	3x 185 mm ² (AWG400)

per connection pole (multi-conductor, insulated, openly suspended). Single cables of, for example, 70 mm² may be replaced by e.g. 2x 35 mm² etc. If the cables are long then the cross section must be increased to avoid voltage loss and overheating.

2.3.6.1 DC terminal types

The table below shows an overview of the various DC terminals. It's recommended that connection of DC cables always utilizes flexible cables with ring lugs.

Type 1: Models up to 200 V	Type 2: Models from 360 V
M10 bolt on a metal rail Recommendation: ring lug with a 11 mm hole	M6 bolt on a metal rail Recommendation: ring lug with a 6.5 mm hole

2.3.6.2 Cable lead and plastic cover

The scope of delivery included a plastic cover for the DC terminal which serve as contact protection. It must always be installed when operating the device. There are breakouts so that the DC cables can be laid in various directions.



The connection angle and the required bending radius for the DC cable must be taken into account when planning the depth of the complete device, especially when installing in a 19" cabinet or similar installations.

Examples for the type 1 terminal:

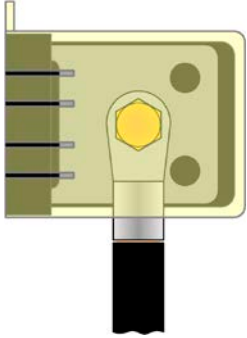

- 90° up or down
- space saving in depth
- no bending radius

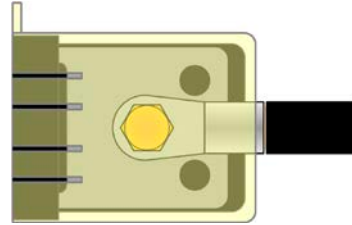

- horizontal lead
- space saving in height
- large bending radius

2.3.7 Grounding of the DC terminal

Besides the main purpose of grounding the enclosure, the extra grounding point (item "7" in 1.8.4.3 or "8" in 1.8.4.8) can be used to ground one of the DC terminal poles. Doing so causes a potential shift on the opposite pole against PE. Because of insulation, there is a maximum allowed potential shift defined for the negative DC terminal pole, which depends on the device model. Refer to "1.8.3. Specific technical data" for the levels.

Both poles on the DC terminal are floating, which is considered as a basic protection in terms of human body safety. Grounding any DC terminal voids that basic protection.



When potential shifting a model with 10 V or 60 V rating on the DC terminal, the safety extra low voltage status (SELV) can turn into a protective extra low voltage (PELV) or leave the safe range. In such a situation, the voltage levels on the DC terminal become hazardous and thus the DC terminal must be covered.



In case any DC pole is grounded, the operator of the device must reinstate the basic protection for human safety by installing appropriate external means, for instance a cover, everywhere the potential of the DC terminal is connected to.

2.3.8 Connection of remote sensing



- Remote sensing is only effective during constant voltage operation (CV) and for other regulation modes the sense input should be disconnected, if possible, because connecting it generally increases the oscillation tendency
- The cross section of the sense cables is noncritical. Recommendation for cables up to 5 m (16.4 ft): use at least 0.5 mm²
- Sense cables shouldn't be twisted, but laid close to the DC cables, i. e. Sense- cable close to DC- cable to the load etc. to damp or avoid possible oscillation. If necessary, an additional capacitor should be installed at the load/consumer to eliminate oscillation
- The Sense+ cable must be connected to DC+ on the load and Sense- to DC- at the load, otherwise the sense input of the power supply can be damaged. For an example see Figure 14 below.
- In master-slave operation, the remote sensing should be connected to the master unit only
- The dielectric strength of the sense wires must always at least match the DC voltage rating!



Dangerous voltage on the sense connectors! The sense cover must always be installed.

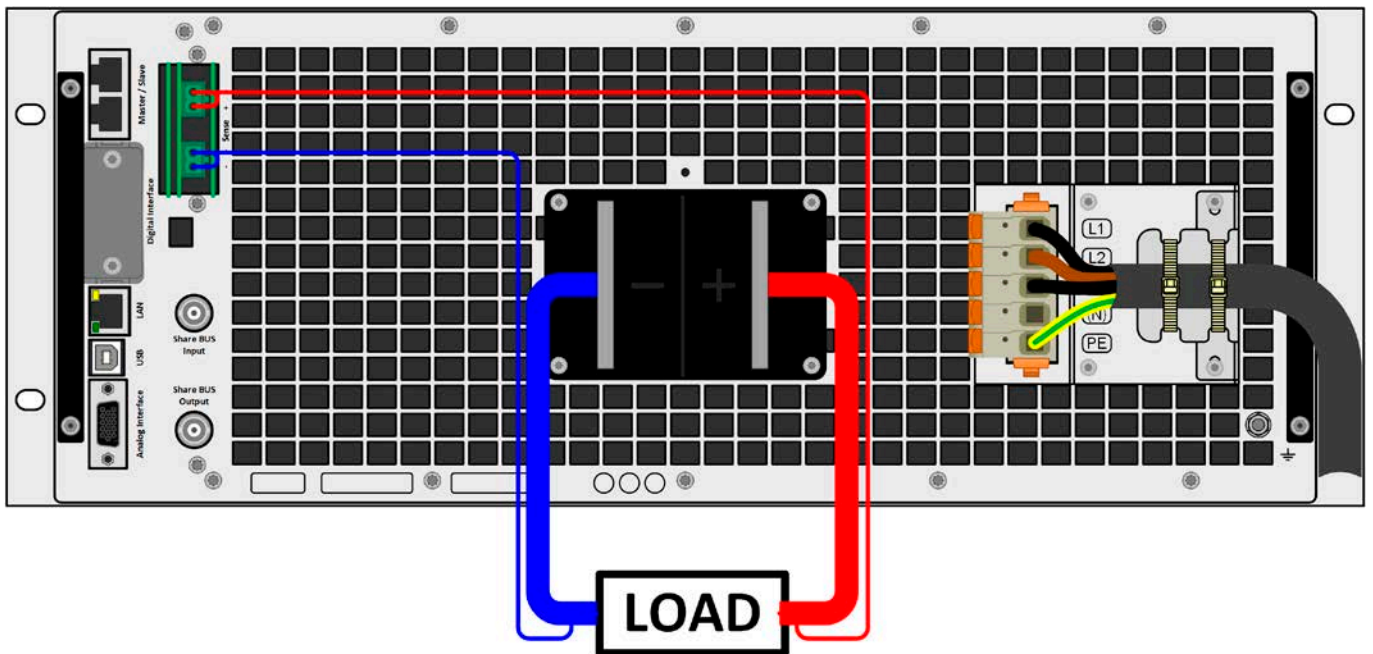
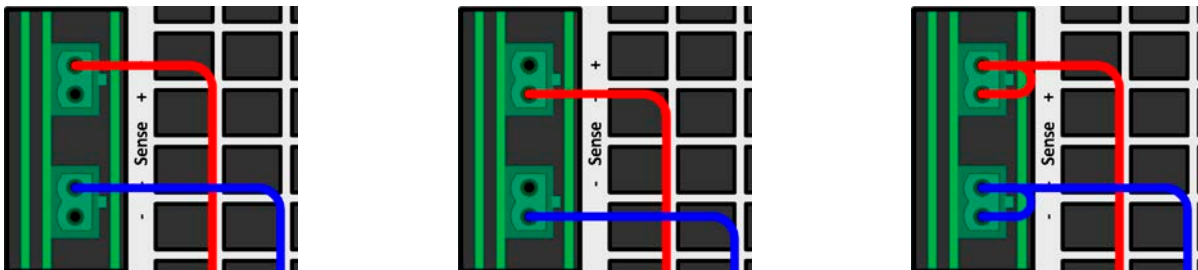

Figure 14 - Example for remote sensing wiring (DC terminal and Sense terminal covers left way for illustrative purposes)

Allowed connection schemes:



2.3.9 Installation of an interface module

The optionally obtainable interface modules can be retrofitted by the user and are exchangeable with each other. The settings for the currently installed module vary and need to be checked and, if necessary, corrected on initial installation and after module exchange.



- Common ESD protection procedures apply when inserting or exchanging a module.
- The device must be switched off before insertion or removal of a module
- Never insert any other hardware other than an interface module into the slot
- If no module is in use it's recommended that the slot cover is mounted in order to avoid internal dirtying of the device and changes in the air flow (models with air-cooling)

Installation steps:

1.

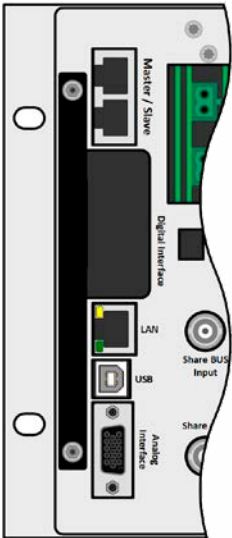

Remove the slot cover. If needed, use a screw driver.

2.

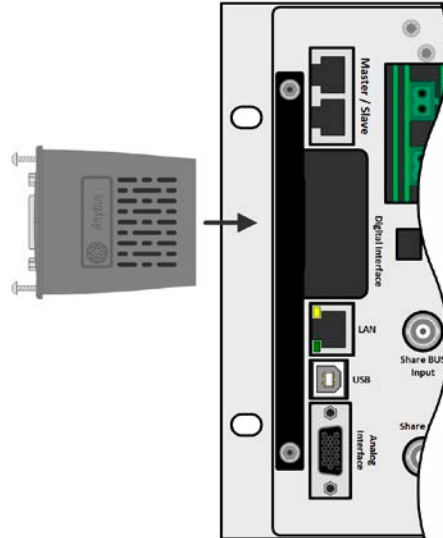

Insert the interface module into the slot. The shape ensures correct alignment.

When inserting take care that it's held as close as possible to a 90° angle to the rear wall of the device. Use the green PCB which you can recognize on the open slot as guide. At the end is a socket for the module.

On the bottom side of the module are two plastic nibs which must click into the green board (PCB) so that the module is properly aligned on the rear wall of the device.

3.

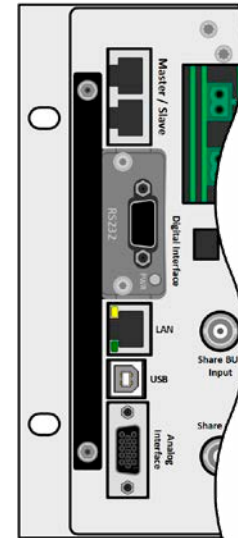

The screws (Torx 8) are provided for fixing the module and should be fully screwed in. After installation, the module is ready for use and can be connected.

Removal follows the reverse procedure. The screws can be used to assist in pulling out the module.

2.3.10 Connection of the analog interface

The 15 pole connector (type: D-sub, VGA) on the rear side is an analog interface. To connect this to a controlling hardware (PC, electronic circuit), a standard plug is necessary (not included in the scope of delivery). It's generally advisable to switch the device completely off before connecting or disconnecting this connector, but at least the DC terminal.

2.3.11 Connection of the Share bus

The "Share BUS" connectors on the rear side (2x BNC type) can be used to connect to the Share bus of further units. The main purpose of the Share bus is to balance the voltage of multiple units in parallel operation, especially when using the integrated function generator of the master unit. For further information about parallel operation refer to section "3.12.1. Parallel operation in master-slave (MS)".

For the connection of the share bus the following must be paid attention to:



- Connection is only permitted between compatible devices (see "1.9.10. "Share BUS" connector" for details) and between a max. of 64 units
- The Share bus of this series works in two directions, for source and sink mode. It's compatible to a few other device series, but it requires careful planning of the entire system, if devices are going to be connected which solely work as sink (el. load) or as source (power supply).

2.3.12 Connection of the USB port (rear side)

In order to remotely control the device via this port, connect the device with a PC using the included USB cable and switch the device on.

2.3.12.1 Driver installation (Windows)

On the initial connection with a PC the operating system will identify the device as new hardware and will try to install a driver. The required driver is for a Communications Device Class (CDC) device and is usually integrated in current operating systems such as Windows 7 or 10. But it's strongly recommended to use and install the included driver installer (on USB stick) to gain maximum compatibility of the device to our softwares.

2.3.12.2 Driver installation (Linux, MacOS)

We can't provide drivers or installation instructions for these operating systems. Whether a suitable driver is available is best carried out by searching the Internet.

2.3.12.3 Alternative drivers

In case the CDC drivers described above are not available on your system, or for some reason do not function correctly, commercial suppliers can help. Search the Internet for suppliers using the keywords "cdc driver windows" or "cdc driver linux" or "cdc driver macos".

2.3.13 Initial commission

For the first start-up after installation of the device, the following procedures have to be executed:

- Confirm that the connection cables to be used are of a satisfactory cross section!
- Check if the factory settings of set values, safety and monitoring functions and communication are suitable for your intended application of the device and adjust them if required, as described in the manual!
- In case of remote control via PC, read the additional documentation for interfaces and software!
- In case of remote control via the analog interface, read the section in this manual concerning analog interfaces!

2.3.14 Commission after a firmware update or a long period of non-use

In case of a firmware update, return of the equipment following repair or a location or configuration change, similar measures should be taken to those of initial start-up. Refer to "2.3.13. Initial commission".

Only after successful checking of the device as listed may it be operated as usual.

3. Operation and application

3.1 Terms

The device is a combination of a power supply and an electronic load. It can work alternately in one of two superior operation modes which are distinguished from each other in several parts of this document below:

- **Source / source mode:**
 - the device works as a power supply, generating and providing DC voltage to an external DC load
 - in this mode, the DC terminal is considered as DC output
- **Sink / sink mode:**
 - the device works as an electronic load, sinking DC energy from an external DC source
 - in this mode, the DC terminal is considered as DC input

3.2 Important notes

3.2.1 Personal safety



- In order to guarantee safety when using the device, it's essential that only persons operate the device who are fully acquainted and trained in the required safety measures to be taken when working with dangerous electrical voltages
- For models which can generate a voltage which is dangerous by contact, or is connected to such, the included DC terminal cover, or an equivalent, must always be used
- Read and follow all safety warnings in section 1.7.1!

3.2.2 General



- When running the device in source mode, unloaded operation is not considered as a normal operation mode and can thus lead to false measurements, for example when calibrating the device
- The optimal working point of the device is between 50% and 100% voltage and current
- It's recommended to not run the device below 10% voltage and current, in order to make sure technical values like ripple and transient times can be met

3.3 Operating modes

A power supply is internally controlled by different control or regulation circuits, which shall bring voltage, current and power to the adjusted values and hold them constant, if possible. These circuits follow typical laws of control systems engineering, resulting in different operating modes. Every operating mode has its own characteristics which is explained below in short form.

3.3.1 Voltage regulation / Constant voltage

Voltage regulation is also called constant voltage operation (**CV**).

The voltage on the DC terminal of the device is held constant on the adjusted value, unless the current or the power according to $P = U_{DC} * I$ reaches the adjusted current or power limit. In both cases the device will automatically change to constant current or constant power operation, whatever occurs first. Then the voltage can't be held constant anymore and will sink (in source mode) or rise (in sink mode) to a value resulting from Ohm's law.

CV is available for both, sink and source mode, and primarily depends on the relation between voltage set value and voltage level on the DC terminal. The device will switch between both modes seamless when adjusting voltage. In source mode, the output voltage in CV mode is equal to the setting while in sink mode the setting must always be lower than the input voltage in order to have the device draw current.

While the DC power stage is switched on and constant voltage mode is active, the condition "CV mode active" will be indicated on the graphics display by the abbreviation **CV** and this message will be passed as a signal to the analog interface, as well stored as status which can also be read as a status message via digital interface.

3.3.1.1 Voltage regulation peaks (source mode)

When working in constant voltage regulation (CV) and source mode the device's internal voltage regulator requires a small transient time to settle the voltage after a load step. Negative load steps, i.e. high load to lower load, will cause the output voltage to overshoot for a short time until compensated by the voltage regulator. The time it takes to settle the voltage can be influenced by switching the voltage regulation speed between the settings **Slow**, **Normal** and **Fast**, whereas Normal is the default. Setting **Slow** will result in a higher transient time and higher voltage drop, but less overshooting, while **Fast** is vice versa. Also see "3.3.7. Dynamic characteristics and stability criteria" and "3.5.3.1. Sub menu "Settings"".

The same occurs with a positive load step, i.e. low load to high load. There the output collapses for a moment. The amplitude of the overshoot resp. collapse depends on the device model, the currently adjusted output voltage and the capacity on the DC output and can thus not be stated with a specific value.

Depictions:

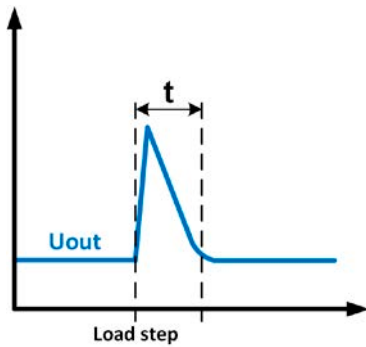

Example for a neg. load step: the DC output will rise above the adjusted value for a short time. t = transient time to settle the output voltage.

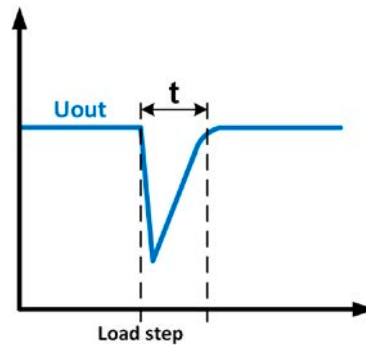

Example for a pos. load step: the DC output will collapse below the adjusted value for a short time. t = transient time to settle the output voltage.

3.3.1.2 Minimum input voltage for maximum current (sink mode)

Due to technical reasons, all models in this series have a minimum internal resistance that requires to provide a specific minimum input voltage (U_{MIN}) in order for the device to be able to sink its rated current (I_{MAX}).

This minimum input voltage varies from model to model and can easily be determined. If less voltage than U_{MIN} is supplied, the load proportionally draws less current, which can be calculated easily.

See principle view to the right.

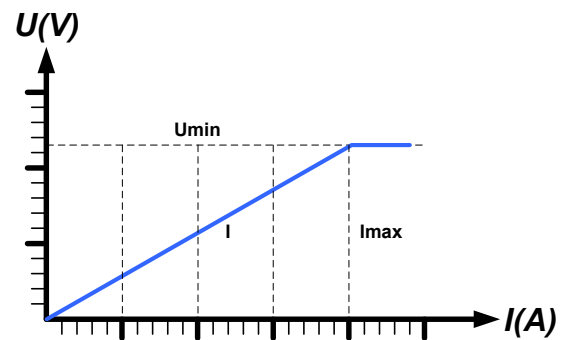

3.3.2 Current regulation / constant current / current limiting

Current regulation is also known as current limiting or constant current mode (**CC**).

The current in the DC terminal of the device is held constant once the output current (source mode) to the load resp. the current consumed from the load (sink mode) reaches the adjusted limit. Then the device automatically switches to CC. In source mode, the current flowing from the power supply is only determined by the output voltage and the load's true resistance. As long as the output current is lower than the adjusted current limit, the device will be either in constant voltage or constant power mode. If, however, the power consumption reaches the set maximum power value, the device will switch automatically to power limiting and set voltage and current according to $P = U * I$.

While the DC power stage is switched on and constant current mode is active, the condition "CC mode active" will be indicated on the graphics display by the abbreviation **CC** and this message will be passed as a signal to the analog interface, as well stored as status which can also be read as via digital interface.

3.3.2.1 Voltage overshootings

In certain situations it's possible that the device generates a voltage overshooting. Such situations are when the device is in CC, with the actual voltage being unregulated, and either a jump in the current set value is initiated which could bring the device out of CC or when the load is suddenly cut from the power supply by an external means. Peak and duration of the overshooting aren't exactly defined, but as rule of thumb it shouldn't exceed a peak of 1-2% of the rated voltage (on top of the voltage setting), while the duration mainly depends on the charging state of the capacities on the DC output and also the capacity value.

3.3.3 Power regulation / constant power / power limiting

Power regulation, also known as power limiting or constant power (CP), keeps the DC power constant if the current flowing to the load (source mode) resp. the current from the source (sink mode) in relation to the voltage reaches the adjusted limit according to $P = U * I$ (sink mode) resp. $P = U^2 / R$ (source mode).

In source mode, the power limiter then regulates the output current according to $I = \sqrt{P / R}$, where R is the load's resistance.

Power limiting operates according to the auto-range principle such that at lower voltages higher current can flow and vice versa, always in order to maintain constant power within the range P_N (see diagram to the right).

While the DC power stage is switched on and constant power mode is active, the condition "CP mode active" will be indicated on the graphics display by the abbreviation CP, as well stored as status which can also be read as a status message via digital interface.

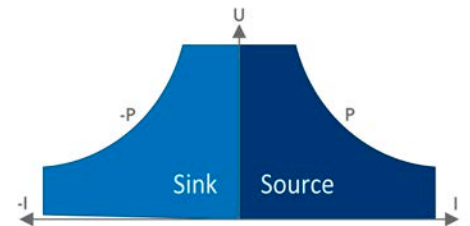

Figure 15 - Power range of 30 kW models

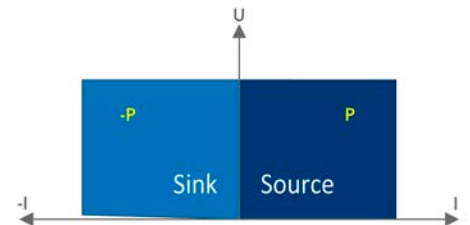

Figure 16 - Power range of the 10 kW model

3.3.3.1 Power derating (only 30 kW models)

As from production date of approx. 02/2022 all models can also operate on a three-phase supply of 208 V (USA, Japan). In order to limit the AC current when running on this low input voltage, the 30 kW models switch to a derating mode which reduces the available DC power to 18 kW. The switchover is determined once when the device is powered and depends on the currently present AC supply voltage. It means that it cannot switch back and forth between derated and underderated mode during operation. The full power is thus only available with AC voltages from 380 V or higher.

Once derated, the device would show a permanent information in the display and all values related to the power are reduced in their adjustment range. This also applies to master-slave operation of derated units.

3.3.4 Internal resistance regulation (source mode)

Internal resistance control (abbr. CR) of power supplies is the simulation of a virtual internal resistor which is in series to the voltage source and thus also in series to the load. According to Ohm's law, this causes a voltage drop, which will result in a difference between adjusted output voltage and actual output voltage. This will work in constant current mode as well as in constant power mode, but here the output voltage will differ even more from the adjusted voltage, because then constant voltage is not active.

The voltage setting in dependency of the resistance set value and the output current is done by calculation of the microcontroller and thus will be slower the other controllers inside the control circuit. Clarification:

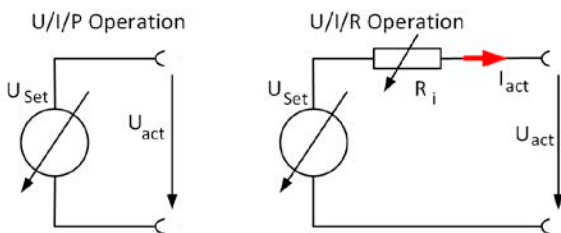

$$U_{Act} = U_{Set} - I_{Act} * R_{Set} \quad \left| \begin{matrix} P_{Set}, I_{Set} \end{matrix} \right.$$

$$P_{Ri} = (U_{Set} - U_{Act}) * I_{Act}$$



With resistance mode being activated the function generator will be unavailable and the actual power value provided by the device does not include the simulated power dissipation of Ri.

3.3.5 Resistance regulation / constant resistance (sink mode)

In sink mode when the device is working as electronic load, which operating principle is based on a variable internal resistance. Constant resistance mode (CR) is almost a natural characteristic. The load attempts to set the internal resistance to the user defined value by determining the input current depending on the input voltage according to formula $I_{IN} = U_{IN} / R_{SET}$, which is derived from Ohm's law.

With series PSB 10000, the difference between an external voltage supplied to the device and the set value of voltage determines the true current. There are two situations:

a) The voltage on the DC input is higher than the voltage set value

In this situation, the above formula extends to $I_{IN} = (U_{IN} - U_{SET}) / R_{SET}$.

An example: the supplied voltage on the DC input is 200 V, the resistance R_{SET} is adjusted to 10 Ω and the voltage set value U_{SET} is set to 0 V. When switching the DC input on the current should go to 20 A and the actual resistance R_{MON} should show approx. as 10 Ω . When adjusting the voltage set value U_{SET} to 100 V now, the current would lower to 10 A while the actual resistance R_{MON} should remain at 10 Ω .

b) The voltage on the DC input is equal to or lower than the voltage set value

The PSB 10000 would not draw any current and enter CV mode. In a situation where the supplied input voltage is approx. equal to or oscillating around the voltage set value, the sink mode would permanently toggle between CV and CR. It's thus not advised to adjust the voltage set value to the same level as the external source.

The internal resistance is naturally limited between almost zero and maximum, where the resolution of current regulation becomes very inaccurate. Because the internal resistance can't have a value of zero, the lower limit is defined to an achievable minimum. This ensures that the internal electronic load, at very low input voltages, can consume a high input current from the source, up to the adjusted current set value.

While the DC input is switched on and constant resistance mode is active, the condition "CR mode active" will be indicated on the graphics display by the abbreviation **CR**, as well it will be stored as internal status that can be read via digital interface.

3.3.6 Sink-source mode switching

The switchover between sink and source mode happens automatically and only depends on the device's voltage setting and actual value on the DC terminal or the remote sense connector, if in use.

It means, that when connecting an external voltage source to the DC terminal, only the voltage set value determines the operation mode. When connecting an external load which can't generate a voltage, only source mode can be run.

Rules for applications with external voltage source connected:

- If the voltage set value is higher than the actual voltage of the external source, the device will run in source mode
- If the voltage set value is lower, it will run in sink mode

To run one of both modes explicitly, i.e. without automatic switchover, it would require following:

- for "source only mode" adjust the current set value for the sink mode to 0
- for "sink only mode" adjust the voltage set value to 0

3.3.7 Dynamic characteristics and stability criteria

When working in sink mode, the device becomes an electronic load which is characterized by short rise and fall times of the current, which are achieved by a high bandwidth of the internal regulation circuit.

In case of testing sources with own regulation circuits at the load, like for example power supplies, a regulation instability may occur. This instability is caused if the complete system (feeding source and electronic load) has too little phase and gain margin at certain frequencies. 180 ° phase shift at > 0dB amplification fulfills the condition for an oscillation and results in instability. The same can occur when using sources without own regulation circuit like batteries and when the connection cables are highly inductive or inductive-capacitive.

The instability is not caused by a malfunction of the load, but by the behavior of the complete system. An improvement of the phase and gain margin can solve this. In practice, this is primarily done by switching the internal voltage regulator between dynamics modes called **Slow**, **Fast** and **Normal**. The switch is either found in the device settings (see 3.5.3.1) or the quick menu (see 3.5.9). The user can only try the different settings to see if the desired effect is achieved. Should there be an improvement due to one of these settings, but the oscillation remains, an additional measure can be to install a capacity directly to the DC input, perhaps alternatively to the remote sense input, if connected to the source. The value to achieve the expected result is not defined and has to be found out. We recommend:

10/60/80 V models: 1000uF...4700uF

200/360 V models: 100uF...470uF

500 V models: 47uF...150uF

750/920/1000 V models: 22uF...100uF

1500/2000 V models: 4.7uF...22uF

3.4 Alarm conditions



This section only gives an overview about device alarms. What to do in case your device indicates an alarm condition is described in section "3.7. Alarms and monitoring".

As a basic principle, all alarm conditions are signaled optically (text + message in the display) and acoustically (if activated), as well as status via digital interface. In addition, the alarms are reported as signals on the analog interface. For later acquisition, an alarm counter can also be shown on display or read via digital interface.

3.4.1 Power Fail

Power Fail (PF) indicates an alarm condition which may have various causes:

- AC input voltage too low (mains undervoltage, mains failure)
- Defect in the input circuit (PFC)
- One or multiple power stages in the device are faulty

As soon as a power fail occurs, the device will stop to supply or sink power and switch off the DC terminal. In case the power fail was an undervoltage and is gone later on, the device can continue to work as before, but this depends on a parameter in the settings menu called **DC terminal -> State after PF alarm**. The default setting would keep the DC terminal switched off, but leave the alarm in the display for notification.



Powering the device down (power switch) can't be distinguished from a supply blackout and thus the device will signalize a PF alarm every time it's switched off. This can be ignored.

3.4.2 Overtemperature

An overtemperature alarm can occur from an excess temperature inside the device and temporarily causes it to switch of the power stage(s). This is usually due to the ambient temperature exceeding the specified operating temperature range of the device. After cooling down, the device can automatically switch the DC terminal back on, depending on the setting of parameter **DC Terminal -> State after OT alarm**. Also see section 3.5.3.1 for more information. The alarm will remain in the display as notification and can be cleared anytime.

3.4.3 Overvoltage protection

An overvoltage alarm (OVP) will switch off the DC power stage and can occur if:

- the device itself, when running in source mode, or an external source (in sink mode) brought a voltage to the DC terminal higher than set for the overvoltage alarm threshold (OVP, 0...110% U_{Nom}) or the connected load somehow returns voltage higher than this threshold
- the OVP threshold has been adjusted too close above the output voltage in source mode and if the device is in CC regulation mode and then experiences a negative load step, it will make the voltage rise quickly, resulting in a voltage overshoot for a short moment which can already trigger the OVP

This function serves to warn the user acoustically or optically that the device probably has generated or experienced an excessive voltage which could damage the connected load application or the device.



- The device is not fitted with protection from external overvoltage and could even be damaged when not powered
- The changeover from operation modes CC -> CV in source mode can cause voltage overshoots

3.4.4 Overcurrent protection

An overcurrent alarm (OCP) will switch off the DC power stage and can occur if:

- the current in the DC terminal reaches the adjusted OCP limit.

This function serves to protect the connected load application (source mode) or the external source (sink mode) so it's not overloaded and possibly damaged due to an excessive current.

3.4.5 Overpower protection

An overpower alarm (OPP) will switch off the DC terminal and can occur if:

- the product of the voltage and current in the DC terminal reaches the adjusted OPP limit.

This function serves to protect the connected load application (source mode) or the external source (sink mode) so it's not overloaded and possibly damaged due to an excessive power.

3.4.6 Safety OVP

This extra feature is only built into the **60 V model** of this series. Similar to the regular overvoltage protection (OVP, see 3.4.3), the Safety OVP is supposed to protect the application or people according to SELV. The alarm shall prevent the device from providing an output voltage higher than 60 V. However, the alarm could also be triggered by an external source providing an excess voltage to the DC input of the device.

A safety OVP alarm can occur if

- the voltage on the DC of the device reaches the rigid threshold of 60.6 V.
- an external voltage of higher than 60.6 V is brought onto the device.

If the voltage on the DC terminal exceeds that level for any reason, the DC terminal will be switched off and alarm **Safety OVP** will be indicated in the display. This alarm can't be acknowledged the usual way. It requires to power-cycle the unit.



During normal operation of the power supply, this alarm should not trigger. There are, however, situations which can trigger the alarm, like when working with voltages close to the threshold of 60.6 V or voltage spikes when leaving CC mode when the current was 0 A before.



When remote sensing is used, i. e. the rear input "Sense" is connected, the true output voltage (source mode) is higher than set value so the Safety OVP could already trigger at voltage settings lower than 60 V.

3.4.7 Share bus fail

A Share bus fail alarm (short: SF) will switch off the DC power stage and can occur if

- the Share bus connectors of at least two units are already wired while at least one unit isn't yet configured for master-slave
- a short-circuit on the Share bus has occurred, for example due to a damaged BNC cable.

This function serves to prevent sending irregular control signals to the slave units via the Share bus or to cause them to react differently. This alarm has to be acknowledged after the cause has been removed. Should the device neither be master nor slave, the Share bus cable should be removed for unimpeded operation.

3.5 Manual operation

3.5.1 Switching on the device

The device should, as far as possible, always be switched on by putting the rotary switch on the front of the device to position 1. Alternatively this can be done using an external cutout (contactor, circuit breaker) of suitable current capacity.

After switching on, the display will first show some device related information (model, firmware versions etc.) and then a language selection screen for 3 seconds. A few seconds later it will show the main screen.

In the **Settings** menu (also see section "3.5.3. Configuration via the menu") in the group **DC terminal** is an option **State after power ON** in which the user can determine the condition of the DC output after power-up. Factory setting here is **Off**, meaning that the DC output will always be switched off after power-up. **Restore** means that the last condition will be restored, either on or off, so the selection here must be considered carefully.

All set values are always saved and restored.



For the time of the start phase the analog interface can signal undefined statuses on its digital outputs. This must be ignored until the device has finished booting and is ready to work.



While manually operated and while also being connected to any remote control equipment via any of the interfaces, the device could be taken over into remote control anytime without warning or request for confirmation. It's thus recommended to block remote control by activating the 'Local' mode for the duration of manual operation.

3.5.2 Switching the device off

The device is switched off by putting the power switch on the front in position 0. Doing so will cause two things: a) the immediate storage of the last condition of the DC output and the most recent set values and b) the occurrence of a PF alarm (power fail) which can be ignored. The DC output is also immediately switched off and after a certain stopping time (up to 30 seconds) the display and the fans will go off and then the device is completely powered off.



The power switch on the front cuts the device physically from the AC grid when in position 0. It thus qualifies as a separator.

3.5.3 Configuration via the menu

The settings menu is meant for the configuration of all operating parameters which are not constantly required. The menu is accessed by finger touch on the **Menu** touch area, but only while the DC terminal is switched off. See figure to the right.

While the DC terminal is switched on the settings menu will not be shown, but some status information.

Menu navigation is also done by finger touch. Inside menus, all values are adjusted using the numeric pad that pops up when tapping a value.

Many settings are self-explanatory, others are not. Those will be explained on the pages following.

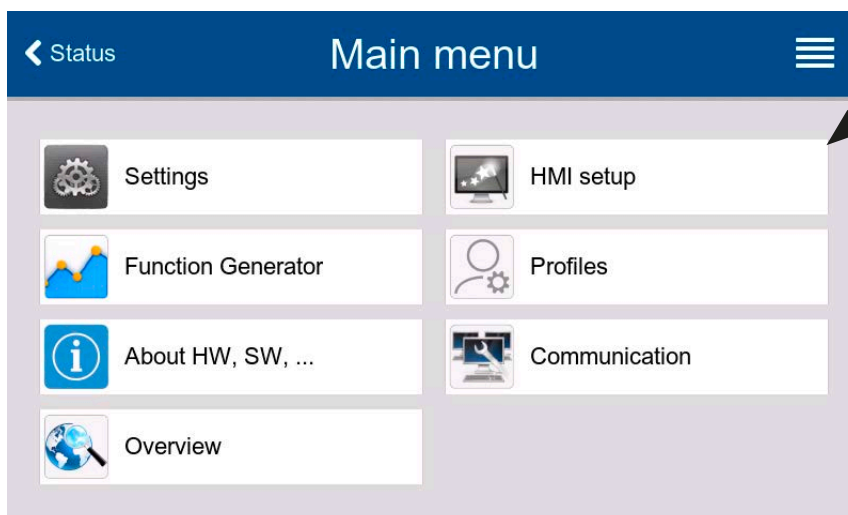



3.5.3.1 Sub menu “Settings”

This sub menu can be accessed directly from the main screen by tapping the Settings button.

Group	Parameters & description
Presets	U, I, P, R
	Presetting of all set values via on-screen numeric pad.
Protection	OVP, OCP, OPP
	Adjust the thresholds of the protections
Limits	U-max, U-min etc.
	Define the adjustment limits (find more information in “3.5.4. Adjustment limits”)
User events	UVD, OVD etc.
	Define supervision thresholds which can trigger user defined events (find more information in “3.7.2.1. User defined events”)
General	Allow remote control
	If remote control is allowed, the device can't be controlled remotely over either the digital or analog interfaces. This situation will be shown as “Local” in the status area on the main display. Also see section 1.9.6.1.
	R mode
	Activates or deactivates the internal resistance control. If activated, the resistance set value and actual will be shown the main screen. For details refer to “3.3.4. Internal resistance regulation (source mode)” and “3.5.6. Manual adjustment of set values”.
	Voltage controller speed
	(Switching the speed only works if the device has already been delivered with firmware KE 3.02 or higher) This switch can be used to select the internal voltage controller speed which, as a result, impacts possible system oscillation. For more information refer to “3.3.7. Dynamic characteristics and stability criteria”. <ul style="list-style-type: none"> • Slow = the voltage controller will be a little slower, the oscillation tendency will decrease • Normal = the voltage controller is on standard speed (Default) • Fast = the voltage controller will be a little faster, the oscillation tendency will increase
Analog interface	SEMI F47
	(Only displayed if the device has already been delivered with firmware KE 3.02 or higher) Activates or deactivates a feature called SEMI F47 which is related to the equally named standard. See “3.12.3. SEMI F47” for more information.
	Range
	Selects the voltage range for the analog set values, actual values and reference voltage output. <ul style="list-style-type: none"> • 0...5 V = Range is 0...100% for set /actual values, reference voltage will be 5 V • 0...10 V = Range is 0...100% for set /actual values, reference voltage will be 10 V Also see “3.6.4. Remote control via the analog interface”
	REM-SB Level
	Selects how the input pin REM-SB of the analog interface shall be working regarding levels (see “3.6.4.3. Analog interface specification”) and logic: <ul style="list-style-type: none"> • Normal = Levels and function as described in the table in 3.6.4.3 • Inverted = Levels and function will be inverted Also see “3.6.4.7. Application examples”

Group	Parameters & description
Analog interface	REM-SB Action
	<p>Selects how the input pin REM-SB of the analog interface shall operate regarding the DC terminal condition outside of analog remote control:</p> <ul style="list-style-type: none"> • DC Off = the pin can only switch the DC power stage off • DC On/Off = the pin can switch the DC power stage off and on again, if it has been switched on before from a different control location
	Pin 6
	<p>Pin 6 of the analog interface (see section "3.6.4.3. Analog interface specification") is by default assigned to signal both device alarms OT and PF. This parameter allows to also enable signaling only one of both (3 possible combinations):</p> <ul style="list-style-type: none"> • Alarm OT = Pin 6 signals only alarm OT • Alarm PF = Pin 6 signals only alarm PF • Alarm PF + OT = Default, pin 6 signals either PF or OT
	Pin 14
	<p>Pin 14 of the analog interface (see section 3.6.4.3) is by default assigned to only signal the device alarm OVP. This parameter allows to also enable signaling the device alarms OCP and OPP in 7 possible combinations:</p> <ul style="list-style-type: none"> • Alarm OVP = Pin 14 signals only OVP • Alarm OCP = Pin 14 signals only OCP • Alarm OPP = Pin 14 signals only OPP • Alarm OVP+OCP = Pin 14 signals OVP or OCP • Alarm OVP+OPP = Pin 14 signals OVP or OPP • Alarm OCP+OPP = Pin 14 signals OCP or OPP • Alarm OVP+OCP+OPP = Pin 14 signals any of the three alarms
	Pin 15
<p>Pin 15 of the analog interface (see section 3.6.4.3) is by default assigned to only signal the regulation mode CV. This parameter allows to enable signaling the DC terminal status (2 options):</p> <ul style="list-style-type: none"> • Regulation mode = Pin 15 signals the CV regulation mode • DC status = Pin 15 signals the DC terminal status 	
VMON/CMON	
<p>Configures how the actual values of voltage and current are represented. If not listed otherwise, the setting doesn't affect the selected signal range (0-5 V or 0-10 V).</p> <ul style="list-style-type: none"> • Default = Current (sink or source mode) on pin 10 (CMON), voltage on pin 9 (VMON) • Actual current (EL) = Pin 10 only signals the actual current in sink mode (EL) • Actual current (PS) = Pin 10 only signals the actual current in source mode (PS) • Mode A = Current of source mode (PS) on pin 9, current of sink mode (EL) on pin 10, the voltage is not signaled in this mode • Mode B = Current of sink mode (EL) on pin 9, current of source mode (PS) on pin 10, the voltage is not signaled in this mode • Actual current (EL) + (PS) = Pin 10 signals a combination of the current in sink and source mode as -100%...0...100% whereas 0% is put in the center of the analog signal range, it means either at 5 V or 2.5 V. Each of both actual values only has half resolution. 	

Group	Parameters & description
DC terminal	State after power ON
	Determines the condition of the DC terminal after power-up. <ul style="list-style-type: none"> • Off = DC terminal is always off after switching on the device • Restore = Default, DC terminal state will be restored from last switch-off
	<div style="border: 1px solid black; padding: 5px;">  <p>The factory default of this setting, also after a device reset, is “Off”. Setting this to “Restore” solely lies within the responsibility of the operator, as the device could automatically start to supply voltage after boot-up, depending on the restored state of the DC terminal. Be careful!</p> </div>
	State after PF alarm
	Determines the condition of the DC terminal after a power fail (PF) alarm: <ul style="list-style-type: none"> • Off = Default, DC terminal remains off • Auto = DC terminal will switch on again after the PF alarm cause is gone, if it has been switched on before the alarm occurred
	State after remote
Determines the condition of the DC terminal after leaving remote control either manually or by command: <ul style="list-style-type: none"> • Off = Default, DC terminal will always be off after leaving remote control • Auto = DC terminal will keep the last state 	
State after OT alarm	
Determines the condition of the DC terminal after an overtemperature (OT) alarm, once the device has cooled down: <ul style="list-style-type: none"> • Off = DC terminal will remain off • Auto = Default, the device will automatically restore the situation before the OT alarm, which usually means the DC terminal to be on 	
Master-slave	Mode
	Selecting Master or Slave enables the master-slave mode (MS) and defines the position for the unit in the MS system. For details see section “3.12.1. Parallel operation in master-slave (MS)”.
	Termination resistor
	Activates or deactivates the so-called bus termination of the digital master-slave bus via a switchable resistor. Termination should be activated if required, usually when problems with the master-slave bus operation occur.
	Bias resistors
	Additionally to the regular termination resistor (TERM) this activates two bias resistor, if required, to help stabilize the bus further. Tap on the information symbol for a graphical depiction.
	Backlight off after 60s
If activated, it will switch off the display’s backlight after 60 seconds of inactivity. This settings is primarily intended for slave units where the display isn’t supposed to be permanently on. It’s identical to the setting in menu “HMI setup”.	
Initialize system	
Tapping this touch area will repeat the initialization of the master-slave system in case the detection of all slave units by the master was unsuccessful, so the system would have less total power than expected, or has to be repeated manually in case the master unit couldn’t detect a missing slave or one slave has failed.	

Group	Parameters & description
USB logging	Log file separator format
	Defines the format of CSV files generated from logging files (also see 1.9.6.5 and 3.5.8). This setting also affects other features where a CSV file can be loaded or saved. <ul style="list-style-type: none"> • US = Comma as column separator (US standard for CSV files) • Default = Semicolon as column separator (german/european standard for CSV files)
	Logging with units (V,A,W)
	CSV files generated from USB logging by default add physical units to values. This can be deactivated here.
	USB logging
	Activates/deactivates logging to USB stick. For more information refer to "3.5.8. Recording to USB stick (logging)".
	Logging interval
	Defines the time between two records in the log file. Selection: 500 ms, 1 s, 2 s, 5 s
	Start/stop
Defines how the USB logging is started and stopped. <ul style="list-style-type: none"> • Manual = Logging only starts and stops upon user interaction on the HMI, by accessing touch button  in the quick menu. • At DC on/off = Logging starts and stops with every change of state on the DC terminal, no matter if caused by the user, software or a device alarm. Attention: Every next start will create a new log file. 	
Reset / Restart	Reset device to defaults
	This touch area will initiate a reset of all settings (HMI, profile etc.) to factory default.
	Restart
	Triggers a warm start

3.5.3.2 Sub menu "Profiles"

See "3.10. Loading and saving user profiles".

3.5.3.3 Sub menu "Overview"

This menu page displays an overview of the set values (U, I, P or U, I, P, R), device alarm thresholds, event settings, adjustment limits, as well as an alarm history which lists the number of device alarms that occurred since the device has been powered.

3.5.3.4 Sub menu "About HW, SW, ..."

This menu page displays an overview of device relevant data such as serial number, article number etc.

3.5.3.5 Sub menu "Function Generator"

See "3.11. The function generator".

3.5.3.6 Sub menu "Communication"

This sub menu offers settings for digital communication via the built-in interfaces USB and Ethernet and also for the optional interface modules of IF-AB series.

There are furthermore adjustable communication timeouts. For more information about these timeout refer to the external, on USB stick included documentation "Programming guide ModBus & SCPI".

The USB itself doesn't require any settings.

Settings for the internal Ethernet port

IF	Settings	Description
Ethernet (internal)	DHCP	The IF allows a DHCP server to allocate an IP address, a subnet mask and a gateway. If no DHCP server is in the network then network parameters will be set as defined below.
	IP address	Manually allocate an IP address.
	Subnet mask	Manually allocate a subnet mask.
	Gateway	Manually allocate a gateway address, if required.
	DNS address	Manually allocate addresses of a Domain Name Server (DNS), if required.
	Port	Select port in the range 0...65535. Default: 5025 Reserved ports: 502, 537
	Host name	User definable host name
	Domain	User definable domain
	MAC address	of the internal Ethernet port

Settings for the optional interface modules (IF-AB-xxx)

IF	Settings	Description
CANopen	Baud Rate	CAN bus baud rate selection that is used by the CANopen interface. Auto = Automatic detection LSS = Baud rate and node address are assigned by the bus master Fixed baud rates: 10 kbps, 20 kbps, 50 kbps, 100 kbps, 125 kbps, 250 kbps, 500 kbps, 800 kbps, 1Mbps
	Node Address	Selection of the CANopen node address in the range 1...127

IF	Settings	Description
Profibus	Node Address	Selection of the Profibus or node address of the device within range 1...125 via direct input
	Function Tag	String input box for a user-definable text which describes the Profibus slave function tag. Max. length: 32 characters
	Location Tag	String input box for a user-definable text which describes the Profibus slave location tag. Max. length: 22 characters
	Installation Date	String input box for a user-definable text which describes the Profibus slave installation date tag. Max. length: 40 characters
	Description	String input box for a user-definable text which describes the Profibus slave. Max. length: 54 characters
	Manufacturer ID	Registered manufacturer ID with the Profibus organization
	Ident number	Product identification number, same as in the GSD file

IF	Settings	Description
Profinet/IO (1 & 2 Port)	Host name	Free choice of host name (default: Client)
	Domain name	Free choice of Domain (default: Workgroup)
	Function Tag	String input box for a user-definable text which describes the Profinet slave function tag. Max. length: 32 characters
	Location Tag	String input box for a user-definable text which describes the Profinet slave location tag. Max. length: 22 characters
	Installation Date	String input box for a user-definable text which describes the Profibus slave installation date tag. Max. length: 40 characters
	Description	String input box for a user-definable text which describes the Profibus slave. Max. length: 54 characters
	Station Name	String input box for a user-definable text which describes the Profinet station name. Max. length: 200 characters

IF	Settings	Description
CAN	Baud rate	Setup of the CAN bus speed or baud rate in typical value between 10 kbps and 1Mbps. Default: 500 kbps
	ID Format	Selection of the CAN ID format and range between Standard (11 Bit ID, 0h...7ffh) and Extended (29 Bit, 0h...1fffffffh)
	Termination	Activates or deactivates CAN bus termination with a built-in resistor. Default: off
	Data length	Determines the DLC (data length) of all messages sent from the device. Auto = length can vary between 3 and 8 bytes Always 8 Bytes = length is always 8, filled up with zeros
	Base ID	Setup of the CAN base ID (11 Bit or 29 Bit, hex format). Default: 0h
	Broadcast ID	Setup of the CAN broadcast ID (11 Bit or 29 Bit, hex format). Default: 7ffh
	Base ID Cyclic Read	Setup of the CAN base ID (11 Bit or 29 Bit, hex format) for cyclic read of several object groups. The device will automatically send object data to the IDs defined with this setting. For more information refer to the programming guide. Default: 100h
	Base ID Cyclic Send	Setup of the CAN base ID (11 Bit or 29 Bit, hex format) for cyclic send of set values along with status. For more information refer to the programming guide. Default: 200h
	Cyclic Read Time: Status	Activation/deactivation and time setting for the cyclic read of status from the adjusted Base ID Cyclic Read Range: 20...5000 ms. Default: 0 ms (deactivated)
	Cyclic Read Time: Set values (PS)	Activation/deactivation and time setting for the cyclic read of set values of U & I (source mode) from the adjusted Base ID Cyclic Read + 2 . Range: 20...5000 ms. Default: 0 ms (deactivated)
	Cyclic Read Time: Limits values 1 (PS)	Activation/deactivation and time setting for the cyclic read of adjustment limits of U & I (source mode) from the adjusted Base ID Cyclic Read + 3 . Range: 20...5000 ms. Default: 0 ms (deactivated)
	Cyclic Read Time: Limits values 2 (PS)	Activation/deactivation and time setting for the cyclic read of adjustment limits of P & R (source mode) to the adjusted Base ID Cyclic Read + 4 . Range: 20...5000 ms. Default: 0 ms (deactivated)
	Cyclic Read Time: Actual	Activation/deactivation and time setting for the cyclic read of actual values from the adjusted Base ID Cyclic Read + 1 Range: 20...5000 ms. Default: 0 ms (deactivated)
	Cyclic Read Time: Set values (EL)	Activation/deactivation and time setting for the cyclic read of set values of I, P and R (sink mode) from the adjusted Base ID Cyclic Read + 5 . Range: 20...5000 ms. Default: 0 ms (deactivated)
	Cyclic Read Time: Limit values (EL)	Activation/deactivation and time setting for the cyclic read of adjustment limits of I, P and R (sink mode) from the adjusted Base ID Cyclic Read + 6 . Range: 20...5000 ms. Default: 0 ms (deactivated)
	Module firmware	CAN module firmware version

IF	Settings	Description
RS232	Baud rate	The baud rate is selectable, other serial settings can't be changed and are defined like this: 8 data bits, 1 stop bit, parity = none Baud rates: 2400Bd, 4800Bd, 9600Bd, 19200Bd, 38400Bd, 57600Bd, 115200Bd

IF	Settings	Description
Slot Ethernet / ModBus-TCP (1 & 2 Port)	DHCP	The IF allows a DHCP server to allocate an IP address, a subnet mask and a gateway. If no DHCP server is in the network then network parameters will be set as defined below.
	IP address	This option is activated by default. An IP address can be manually allocated.
	Subnet mask	Here a subnet mask can be defined if the default subnet mask is not suitable.
	Gateway	Here a gateway address can be allocated if required..
	DNS address	Here the addresses of the first and second Domain Name Servers (DNS) can be defined, if needed.
	Port	Range: 0...65535, default port: 5025 = Modbus RTU Reserved ports: 502, 537
	Host name	User definable host name (default: Client)
	Domain	User definable domain (default: Workgroup)
	MAC address	of the internal Ethernet port
	Speed / Duplex Port 1	Manual selection of transmission speed (10MBit/100MBit) and duplex mode (full/half). It's recommended to use the Auto option and only revert to another option if Auto fails.
	Speed / Duplex Port 2	Different Ethernet port settings for 2-port modules are possible, as these include an Ethernet switch

Further communication related parameters

Group	Parameters & description
Timeouts	TCP keep-alive (internal) / TCP keep-alive (slot)
	Activates/deactivates keep-alive network functionality for the internal Ethernet port and for an a standard Ethernet module (IF-AB-ETHxx), if installed in the slot. The "keep-alive" network packets are used to keep the socket connection open. As long as keep-alive is valid in the network, the device will disable the Ethernet timeout. Also see below at Timeout ETH .
	Timeout USB/RS232
	Defines the max. time between two subsequent bytes or blocks of a transferred message. For more information about the timeout refer to the external programming documentation "Programming ModBus & SCPI". Default value: 5 ms , Range: 5...65535
	Timeout ETH (internal) / Timeout ETH (slot)
	Defines a timeout after which the device would close the socket connection if there was no command communication between the controlling unit (PC, PLC etc.) and the device for the adjusted time. The timeout is ineffective as long as option TCP keep-alive is enabled for the particular interface and the keep-alive network service is running. A setting of 0 would deactivate the timeout permanently. Default value: 5 s , Range: 0 / 5...65535 (0 = timeout deactivated)
Protocols	Interface monitoring / Timeout Interface monitoring
	Activates/deactivates the interface monitoring (see section "3.6.3.3. Interface monitoring"). Default values: off, 5 s / Range: 5..65535
	Communication protocols
	Enables or disables SCPI or ModBus communication protocols for the device. The change is immediately effective. Only one of both can be disabled.
	ModBus specification compliance
	Allows to switch from Limited (default setting) to Full which makes the device send messages in ModBus RTU or ModBus TCP format which fully comply to the specification and are compatible to softwares available on the market. With Limited the device would still use the old, partially wrong message format (see programming guide for details).

3.5.3.7 Menu “HMI Setup”

These settings refer exclusively to the control panel (HMI).

Group	Parameters & description
Language	Selection of the display language (default: English)
Sound	Key sound
	Activates or deactivates sounds when touching a touch area in the display. It can acoustically signal that the action has been accepted.
	Alarm sound
	Activates or deactivates the additional acoustic signal of an alarm or user defined event which has been set to Action = Alarm . See also “3.7. Alarms and monitoring”.
Clock	Internal clock and date setup
Backlight	Backlight off after 60s
	The choice here is whether the backlight remains permanently on (default) or if it should go off when no input via screen or rotary knob is done for 60 s. As soon as there is input, the backlight returns automatically. Furthermore, the backlight intensity can be adjusted here.
Lock	See “3.8. Locking the control panel (HMI)” and “3.9. Locking the adjustment limits and user profiles”

3.5.4 Adjustment limits



Adjustment limits are only effective on the related set values, no matter if using manual adjustment or remote control setting!



Defaults are that all set values (U, I, P, R) are adjustable from 0 to 102%, except for the voltage with the 60 V model which is adjustable to 100%.

The full range may be obstructive in some cases, especially for protection of applications against overvoltage. Therefore upper and lower limits for current (I) and voltage (U) can be set separately, which then limit the range of the adjustable set values.

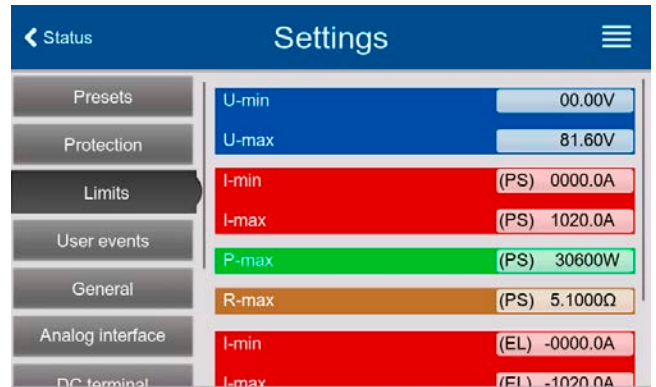
For power (P) and resistance (R) only upper value limits can be set.



► How to configure the adjustment limits

1. While the DC terminal is switched off, tap  on the main screen.
2. Tap on group **"Limits"** on the left side to open the list of limits. They are grouped and colored for distinction. Values are adjusted by tapping on them, in a window popping up with a numeric pad. Values further down in the list are accessed by swiping the list up.
3. Adjust the desired value and submit with .



The adjustment limits are coupled to the set values. It means, that the upper limit may not be set lower than the corresponding set value. Example: If you wish to set the limit for the power set value (P-max) to 6000 W while the currently adjusted power set value is 8000 W, then the set value first would have to be reduced to 6000 W or less, in order to set P-max down to 6000 W.

3.5.5 Changing the operating mode

In general, the manual operation of the device distinguishes between three operating modes: U/I, U/P and U/R. They are tied to set value input using the rotary knobs or the on-screen numeric pad. The current assignment can be switched anytime if you want to adjust a set value which is currently not assigned to any of the knobs.

► How to change the operating mode (two options)

1. Unless the device is in remote control or the panel is locked, tap on the depiction of the right-hand knob on the screen (see figure to the right) to change its assignment between I, P and R (if resistance mode is activated) for source mode (PS) and after that to I, P and R for sink mode (EL). The knob will display accordingly, with letters.
2. Directly tap on the colored areas with the set values, like shown in the figure to the right. The set value field, when inverted, indicates the assignment to the knob. In the example in the figure it has U and I (sink) assigned, which means U/I mode.

Depending on the selection the right rotary knob will be assigned different setting values, the left knob is always assigned to the voltage.



In order to change the other values, like P or R while U/I is active, and without switching the assignment all the time, direct input can be used. See section 3.5.6.

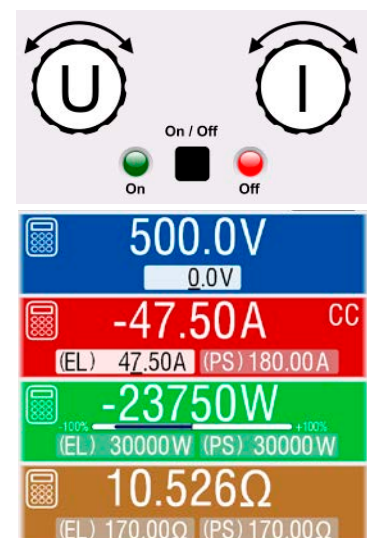

The actual operating mode, which is only indicated while the DC terminal is switched on, solely depends only on the set values. For more information see section "3.3. Operating modes".

3.5.6 Manual adjustment of set values

The set values for voltage, current and power are the fundamental operating possibilities of a power supply and hence the two rotary knobs on the front of the device are always assigned to two of the values in manual operation.

For each mode, sink and source, the device has separately adjustable set values for current, power and resistance which are labeled accordingly in the display. “(PS)” stands for source mode while “(EL)” is for sink mode.

The resistance value is connected to the “R mode” which has to be activated separately, for instance via the quick menu. Refer to “3.5.3. Configuration via the menu” as well as “3.3.4. Internal resistance regulation (source mode)” and “3.3.5. Resistance regulation / constant resistance (sink mode)” for details.

Set values can be entered manually in two ways, via **rotary knob** or **direct input**. While the rotary knobs adjust values continuously, entering them via numeric pad can be used to change values in bigger steps.



Changing a value is immediately submitted, no matter if the DC terminal is switched on or off.



When adjusting set values, upper and lower limits may come into effect. See section “3.5.4. Adjustment limits”. Once a limit is reached, the display will show a small note like “Limit: U-max” etc. for a short time in proximity to the adjusted value.

► How to adjust set values U, I, P or R with the rotary knobs

1. First check if the value you want to change is already assigned to one of the rotary knobs. The main screen displays the assignment as depicted in the figure to the right.
2. If, as shown in the example, the assignment is voltage (U, left knob) and current (I, right knob), and it's required to set the power, then the assignment of the right-hand knob can be changed by tapping on its depiction until it shows “P”. In the left-hand display area one of the set values of power, for sink or source mode, is indicated as selected by its unit being display inverted.
3. After successful selection, the desired value can be set within the defined limits. Selecting the next digit is done by pushing the rotary knob which shifts the cursor from right to left (selected digit will be underlined):

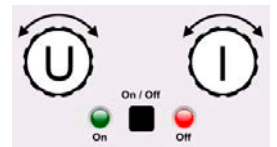

(EL) 47.50A → (EL) 47.50A → (EL) 47.50A

► How to adjust values via direct input:

1. In the main screen, depending on the rotary knob assignment, values can be set for voltage (U), current (I), power (P) or resistance (R) via direct input by tapping on one of the small ten-key pad symbols, for example the one in the blue area if you wanted to adjust the voltage.
2. Enter the required value using the ten-key pad. Similar to a pocket calculator the key **C** clears the input. Decimal values are set by tapping the point key. For example, 54.3 V is entered with **5** **4** **.** **3** and **Enter**.
3. Unless the new values isn't rejected for some reason, the display would then switch back to the main page and the set value would be submitted to the DC terminal.

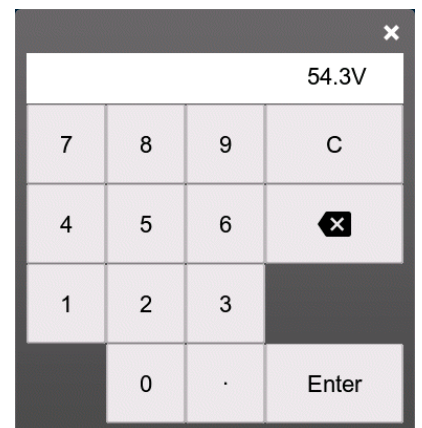

Upon entering a value which exceeds the corresponding limit, a note would pop up, the value in the frame reset to 0 and not be accepted and submitted.

3.5.7 Switching the DC terminal on or off

The DC terminal of the device can be manually or remotely switched on and off. After the DC terminal has been switched on, it can either work as a DC input (sink mode) or DC output (source mode). More information can be found in "3.3.6. Sink-source mode switching".



Switching the DC terminal on during manual operation or digital remote control can be disabled by pin REM-SB of the built-in analog interface. For more information refer to 3.5.3.1 and example a) in 3.6.4.7.

► How to manually switch the DC terminal on or off

1. As long as the control panel is not completely locked press the button **On/Off**. Otherwise you are asked to disable the HMI lock. In case the HMI lock is connected to a PIN, you are asked to enter the PIN first.
2. With the possible HMI lock removed, button **On/Off** toggles the DC terminal state, as long as this is not restricted by an alarm or the device being in remote control.

► How to remotely switch the DC terminal on or off via the analog interface

1. See section "3.6.4. Remote control via the analog interface".

► How to remotely switch the DC terminal on or off via the digital interface

1. See the external documentation "Programming Guide ModBus & SCPI" if you are using custom software, or refer to the external documentation from LabVIEW VIs or other software provided by the manufacturer.

3.5.8 Recording to USB stick (logging)

Device data can be recorded to USB stick (USB 3.0 is supported, but not all memory sizes) anytime. For specifications of the USB stick and the generated log files refer to section "1.9.6.5. USB port (front side)".

The logging stores files of CSV format on the stick where the layout of the log data is the same as when logging via PC with software EA Power Control. The advantage of USB logging over PC logging is the mobility and that no PC is required. The logging feature just has to be activated and configured in the Settings.

3.5.8.1 Restrictions

USB logging in this form isn't available or automatically deactivated if the battery test logging in the battery test is activated or the PV function **EN50530** is configured and loaded.

3.5.8.2 Configuration



Also see section 3.5.3.6. After USB logging has been enabled and the parameters **Logging interval** and **Start/Stop** have been set, logging can be started anytime after leaving the **Settings** menu.



Furthermore see section 3.5.3.1. There are additional settings for the CSV file itself as generated by the USB logging features. You can switch the column separator format between german/european standard (**Default**) or US american standard (**US**). The other option is used to deactivate the physical unit that is added by default to every set/actual value in the log file. Deactivating this option simplifies the CSV file processing in MS Excel or similar tools.

3.5.8.3 Handling (start/stop)

With setting **Start/stop** to **At DC on/off** logging will start each time the DC terminal of the device is switched on, no matter if manually with the front button **On/Off** or remotely via analog or digital interface. With setting **Manual** it's different. Logging is then started and stopped only in the quick menu (see figure to the right).



Button  starts logging manually and changed to , which is for manual stop.

Soon after logging has been started, the symbol  indicates the ongoing logging action. In case there is an error while logging, such as the USB stick is full or removed, it will be indicated by another symbol . After every manual stop or switching the DC terminal off the logging is stopped and the log file closed.

3.5.8.4 USB logging file format

Type: text file in german/european or US american CSV format (depending on the selected setting)

Layout (default german format shown):

	A	B	C	D	E	F	G	H	I	J	K	L	M	N	O	P
1	U set	U actual	I set (PS)	I actual	P set (PS)	P actual	R set (PS)	R actual	R mode	I set (EL)	P set (EL)	R set (EL)	Output/Input	Device mode	Error	Time
2	0,0V	50,0V	5,00A	-30,00A	15000W	-1500W	N/A	N/A	OFF	50,00A	15000W	N/A	ON	NONE	NONE	00:00:00,354
3	0,0V	50,0V	5,00A	-40,00A	15000W	-2000W	N/A	N/A	OFF	50,00A	15000W	N/A	ON	NONE	NONE	00:00:00,854
4	0,0V	50,0V	5,00A	-20,00A	15000W	-1000W	N/A	N/A	OFF	50,00A	15000W	N/A	ON	NONE	NONE	00:00:01,354
5	0,0V	50,0V	5,00A	0,00A	15000W	0W	N/A	N/A	OFF	50,00A	15000W	N/A	OFF	NONE	NONE	00:00:01,854

Legend:

U set: Voltage set value

U actual / I actual / P actual / R actual: Actual values

I set (PS) / P set (PS) / R set (PS): Set values I, P and R belonging to source mode (PS)

I set (EL) / P set (EL) / R set (EL): Set values I, P and R belonging to source mode (EL)

R mode: Resistance mode activated/deactivated (also called 'UIR mode')

Output/Input: State of the DC terminal

Device mode: Actual regulation mode (also see "3.3. Operating modes")

Error: Device alarms

Time: Elapsed time since logging start

Important to know:

- R set and R actual are only recorded if "R mode" is active (refer to section 3.5.5)
- Unlike the logging on PC, every log start here creates a new log file with a counter in the file name, starting generally with 1, but minding existing files

3.5.8.5 Special notes and limitations

- Max. log file size (due to FAT32 formatting): 4 GB
- Max. number of log files in folder HMI_FILES: 1024
- With setting **Start/stop** being **At DC on/off**, the logging will also stop on alarms or events with action **Alarm**, because they switch off the DC terminal
- With setting **Start/stop** being **Manual**, the device will continue to log even on occurring alarms, so this mode can be used to determine the period of temporary alarms like OT or PF

3.5.9 The quick menu

The device offers a quick menu which allows for the quick access to often used features and modes being switched on or off in the "Settings" menu. It can be opened by swiping up from the bottom screen edge or tapping the bar:

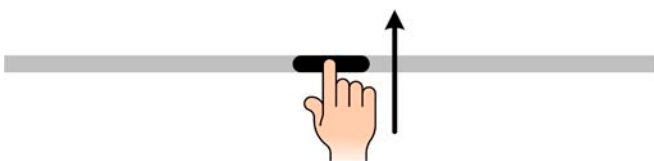

Overview:



Tapping a button activates or deactivates the feature. Buttons with black on white indicate an activated feature:

Symbol	Belongs to	Meaning
	USB logging	USB logging is running (the symbols is only available when USB logging has been activated in menu "Settings")
	Master-slave	Master-slave activated, device is master
	Master-slave	Master-slave activated, device is slave
	Master-slave	Master-slave deactivated
	Resistance mode	R mode = on
	HMI	Alarm sound = on
	HMI	Key sound = on
	HMI	Opens the graph screen
	Operation modes	Switches voltage controller speed between Slow , Normal (default) and Fast (see 3.3.7)
	HMI	Adjust backlight intensity
	HMI	Opens the main menu

3.5.10 The graph

The devices feature a manually callable, HMI operated visual depiction of the temporal run of the actual values of voltage, current and power, called the graph. It isn't a recording feature whatsoever. For data recording in the background there is still the USB logging feature (see 3.5.8).

In normal operation the graph can be called anytime via the quick menu, while in function generator operation it's called by an extra screen button. Once called, it completely fills the screen.



Limited control options available while the graph is up! For safety reasons it's, however, possible to switch off the DC terminal anytime.

Overview:

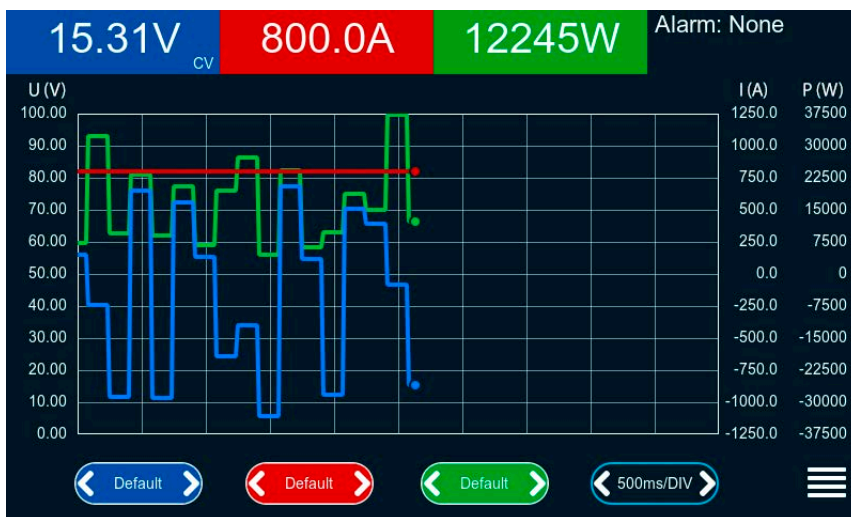

Controls:

- Tapping the **middle** of the three red/green/blue touch areas deactivates/activate the corresponding plot
- Tapping the **sides** (arrows left/right) of the red/green/blue touch areas increases/decreases the vertical scaling
- Tapping the **sides** (arrows left/right) of the black touch area increases/decreases the horizontal scaling
- Swiping on the three scales (Y axis) moves them up or down
- Tapping the menu touch area exits the graph screen anytime

3.6 Remote control

3.6.1 General

Remote control is possible via one of the built-in interfaces (analog, USB, Ethernet) or via one of the optional interface modules. One of the digital interface is the master-slave bus. It means that a Slave model is supposed to be controlled from a master unit via the master-slave bus. Controlling a Slave device via its rear USB port is considered an exception.

Important here is that only the analog or any digital interface can be in control. It means that if an attempt was made to switch to remote control via the digital interface whilst analog remote control is active (pin REMOTE = LOW) the device would report an error via the digital interface. In the opposite direction, a switch-over via pin REMOTE would be ignored. However, status monitoring and reading of values are always possible.

3.6.2 Control locations

Control locations are those locations from where the device can be controlled. Essentially there are two: at the device (manual operation) and external (remote control). The following locations are defined:

Displayed location	Description
Remote: None	If neither of the other locations is displayed then manual control is active and access from the analog and digital interfaces is allowed.
Remote: <interface_name>	Remote control via any interface is active
Local	Remote control is locked, only manual operation is allowed.

Remote control may be allowed or inhibited using the setting **Allow remote control** (see "3.5.3.1. Sub menu "Settings"). In inhibited condition the status "Local" will be displayed top right. Activating the inhibit can be useful if the device is remotely controlled by software or some electronic device, but it's required to make adjustments at the device or deal with emergency.

Activating condition **Local** causes the following:

- If remote control via the digital interface is active (e. g. **Remote: USB**), then it's immediately terminated and in order to continue remote control once **Local** is no longer active, it has to be reactivated at the PC
- If remote control via the analog interface is active (**Remote: Analog**), then it's temporarily interrupted until remote control is allowed again by deactivating **Local**, because pin REMOTE continues to signal "remote control = on", unless this has been changed during the **Local** period.

3.6.3 Remote control via a digital interface

3.6.3.1 Selecting an interface

In addition to the built-in USB and Ethernet ports, all models of this series support the following optionally available interface modules:

Short ID	Type	Ports	Description*
IF-AB-CANO	CANopen	1	CANopen slave with generic EDS
IF-AB-RS232	RS232	1	Standard RS232, serial
IF-AB-PBUS	Profibus	1	Profibus DP-V1 slave
IF-AB-PNET1P	ProfiNet	1	Profinet DP-V1 slave
IF-AB-PNET2P	ProfiNet	2	Profinet DP-V1 slave, with switch
IF-AB-CAN	CAN	1	CAN 2.0 A / 2.0 B
IF-AB-ECT	EtherCAT	2	Standard EtherCAT slave with CoE
IF-AB-MBUS1P	ModBus TCP	1	ModBus TCP protocol via Ethernet
IF-AB-MBUS2P	ModBus TCP	2	ModBus TCP protocol via Ethernet

* For technical details of the various modules see the extra documentation "Programming Guide Modbus & SCPI"

3.6.3.2 Programming

Programming details for the rear interfaces, the communication protocols etc. are to be found in the documentation "Programming Guide Modbus & SCPI" which is supplied on the included USB stick or which is available as download from the manufacturer's website.

3.6.3.3 Interface monitoring

Interface monitoring is a configurable functionality introduced in firmwares KE 2.06 and HMI 2.08. Its goal is to monitor (or supervise) the communication line between the device and a superior control unit, such as PC or PLC, and to ensure that the device wouldn't continue working uncontrolled in case the communication line fails. A failing line can mean that it's either physically interrupted (damaged cable, bad contact, cable pulled) or the interface port inside the device hangs.

The monitoring is always only valid for one of the digital interfaces, the one being used for remote control. It thus means that the monitoring can become temporarily inactive when the device leaves remote control. It's furthermore based on a user-definable timeout which would run out if not at least one message is sent to the device within the given time frame. After every message, the timeout would start again and reset with the next message coming. In case it runs out, following reaction of the device is defined:

- Exit remote control
- In case the DC output is switched on, it either switches it off or leaves it on, as defined by the parameter **DC terminal -> State after remote** (see 3.5.3.1)

Notes for the operation:

- The timeout of the monitoring can be changed anytime via remote control; the new value would only be valid after the current timeout has elapsed
- The interface monitoring doesn't deactivate the Ethernet connection timeout (see 3.5.3.6), so these two timeouts can overlap

3.6.4 Remote control via the analog interface

3.6.4.1 General

The galvanically isolated, 15-pole analog interface, as built-in and below referenced in short form as AI, is located on the rear side of the device offers the following possibilities:

- Remote control of current, voltage, power and resistance
- Remote status monitoring (CV, DC terminal)
- Remote alarm monitoring (OT, OVP, PF, OCP, OPP)
- Remote monitoring of actual values
- Remote on/off switching of the DC terminal

Setting the **three** set values of voltage, current and power via the analog interface must always be done concurrently. It means, for example, that the voltage can't be given via the AI and current and power set by the rotary knobs or vice versa. The internal resistance set value can additionally be adjusted. Contrary to manual adjustment or via digital interface, the analog interface doesn't offer separate set values of power and current for the source and sink mode.

Analog set values can be supplied by an external voltage or generated from the reference voltage on pin 3. As soon as remote control via the analog interface is activated, the displayed set values will be those provided by the interface. The AI can be operated in the common voltage ranges 0...5 V and 0...10 V, both representing 0...100% of the nominal value. The selection of the voltage range can be done in the device setup. See section "3.5.3. Configuration via the menu" for details. The reference voltage sent out from pin 3 (VREF) will be adapted accordingly:

0-5 V: Reference voltage = 5 V, 0...5 V set value (VSEL, CSEL, PSEL, RSEL) correspond to 0...100% of the rated value or $R_{Min}...R_{Max}$, 0...100% of the actual values correspond to 0...5 V at the outputs CMON and VMON, at least as long these two pins are still configured for the default (see section "3.5.3. Configuration via the menu").

0-10 V: Reference voltage = 10 V, 0...10 V set value (VSEL, CSEL, PSEL, RSEL) correspond to 0...100% of the rated value or $R_{Min}...R_{Max}$, 0...100% of the actual values correspond to 0...10 V at the outputs CMON and VMON, at least as long these two pins are still configured for the default (see section "3.5.3. Configuration via the menu").

All set values are always additionally limited to the corresponding adjustment limits (U-max, I-max etc.), which would clip setting excess values for the DC output. Also see section "3.5.4. Adjustment limits".

Before you begin, please read these important notes about the use of the interface:



After powering the device and during the start phase the AI signals undefined statuses on the output pins. Those must be ignored until it's ready to work.

- Analog remote control of the device must be activated by switching pin REMOTE (5) first. Only exception is pin REM-SB, which can be used independently
- Before the hardware is connected that will control the analog interface, it shall be checked that it can't provide voltage to the pins higher than specified
- Set value inputs, such as VSEL, CSEL, PSEL and RSEL (if R mode is activated), must not be left unconnected (i.e. floating) during analog remote control. In case any of the set values is not used for adjustment, it can be tied to a defined level or connected to pin VREF (solder bridge or different), so it gives 100%
- Switching between sink and source mode can only be done with the voltage level on pin VSEL. Also see example d) in 3.6.4.7.

3.6.4.2 Acknowledging device alarms

In case of a device alarm occurring during remote control via analog interface, the DC terminal will be switched off the same way as in manual control. The device would indicate an alarm (see 3.7.2) in the front display and, if activated, acoustically and also signal most of them on the analog interface. Which alarms actually are signaled can be set up in the device configuration menu (see "3.5.3.1. Sub menu "Settings").

Most device alarms have to be acknowledged (also see "3.7.2. Device alarm and event handling"). Acknowledgment is done with pin REM-SB switching the DC terminal off and on again, which represents a HIGH-LOW-HIGH signal (min. 50ms for LOW), when using the default level setting for this pin.

There is one **exception**: the SOVP (Safety OVP) alarm, which is only featured with the 60 V model of this series. It can't be acknowledged and requires to power-cycle the device. It can be monitored via the analog interface and would be indicated by the alarms PF and OVP being signaled at the same time, so it would require to select the alarm indication on pin 6 to at least signal PF and for pin 14 to signal OVP in any of the combinations.

3.6.4.3 Analog interface specification

Pin	Name	Type ⁽¹⁾	Description	Default levels	Electrical specifications
1	VSEL	AI	Voltage set value	0...10 V or 0...5 V correspond to 0..100% of U_{Nom}	Accuracy 0-5 V range: < 0.4% ⁽⁵⁾ Accuracy 0-10 V range: < 0.2% ⁽⁵⁾
2	CSEL	AI	Current set value (source & sink)	0...10 V or 0...5 V correspond to 0..100% of I_{Nom}	Input impedance $R_i > 40\text{ k} \dots 100\text{ k}$
3	VREF	AO	Reference voltage	10 V or 5 V	Tolerance < 0.2% at $I_{max} = +5\text{ mA}$ Short-circuit-proof against AGND
4	DGND	POT	Ground for all digital signals		For control and status signals
5	REMOTE	DI	Switches between manual and remote control	Remote = LOW, $U_{Low} < 1\text{ V}$ Manual = HIGH, $U_{High} > 4\text{ V}$ Manual, if pin not wired	Voltage range = 0...30 V $I_{Max} = -1\text{ mA}$ at 5 V $U_{LOW\ to\ HIGH\ typ.} = 3\text{ V}$ Rec'd sender: Open collector against DGND
6	ALARMS 1	DO	Overheating /power fail alarm	Alarm = HIGH, $U_{High} > 4\text{ V}$ No alarm = LOW, $U_{Low} < 1\text{ V}$	Quasi open collector with pull-up against V_{cc} ⁽²⁾ With 5 V on the pin max. flow +1 mA $I_{Max} = -10\text{ mA}$ at $U_{CE} = 0,3\text{ V}$ $U_{Max} = 30\text{ V}$ Short-circuit-proof against DGND
7	RSEL	AI	Resistance value (source & sink)	0...10 V or 0...5 V correspond to $R_{Min} \dots R_{Max}$	Accuracy 0-5 V range: < 0.4% ⁽⁵⁾ Accuracy 0-10 V range: < 0.2% ⁽⁵⁾
8	PSEL	AI	Power set value (source & sink)	0...10 V or 0...5 V correspond to 0..100% of P_{Nom}	Input impedance $R_i > 40\text{ k} \dots 100\text{ k}$
9	VMON	AO	Actual voltage	0...10 V or 0...5 V correspond to 0..100% of U_{Nom} ⁽⁵⁾	Accuracy 0-5 V range: < 0.4% ⁽⁵⁾ Accuracy 0-10 V range: < 0.2% ⁽⁵⁾
10	CMON	AO	Actual current	0...10 V or 0...5 V correspond to 0..100% of I_{Nom} ⁽⁵⁾	$I_{Max} = +2\text{ mA}$ Short-circuit-proof against AGND
11	AGND	POT	Ground for all analog signals		For xSEL, xMON and VREF
12	R-ACTIVE	DI	R mode on / off	Off = LOW, $U_{Low} < 1\text{ V}$ On = HIGH, $U_{High} > 4\text{ V}$ On, if pin not wired	Voltage range = 0...30 V $I_{Max} = -1\text{ mA}$ at 5 V $U_{LOW\ to\ HIGH\ typ.} = 3\text{ V}$ Rec'd sender: Open collector against DGND
13	REM-SB	DI	DC terminal OFF (DC terminal ON) (ACK alarms ⁽⁴⁾)	Off = LOW, $U_{Low} < 1\text{ V}$ On = HIGH, $U_{High} > 4\text{ V}$ On, if pin not wired	Voltage range = 0...30 V $I_{Max} = +1\text{ mA}$ at 5 V Rec'd sender: Open collector against DGND
14	ALARMS 2	DO	Overvoltage alarm Overcurrent alarm Overpower alarm	Alarm = HIGH, $U_{High} > 4\text{ V}$ No alarm = LOW, $U_{Low} < 1\text{ V}$	Quasi open collector with pull-up against V_{cc} ⁽²⁾ With 5 V on the pin max. flow +1 mA $I_{Max} = -10\text{ mA}$ at $U_{CE} = 0,3\text{ V}$, $U_{Max} = 30\text{ V}$ Short-circuit-proof against DGND
15	STATUS ⁽³⁾	DO	Constant voltage regulation active DC terminal	CV = LOW, $U_{Low} < 1\text{ V}$ CC/CP/CR = HIGH, $U_{High} > 4\text{ V}$ Off = LOW, $U_{Low} < 1\text{ V}$ On = HIGH, $U_{High} > 4\text{ V}$	Short-circuit-proof against DGND

(1) AI = Analog Input, AO = Analog Output, DI = Digital Input, DO = Digital Output, POT = Potential

(2) Internal V_{cc} approx. 10 V

(3) Only one of both signals possible, see section 3.5.3.1

(4) Only during remote control

(5) The error of a set value input adds to the general error of the related value on the DC terminal of the device

3.6.4.4 Resolution

The analog interface is internally sampled and processed by a digital micro-controller. This causes a limited resolution of analog steps. The effective resolution is the same for set values (VSEL etc.) and actual values (VMON/CMON). It's 26214 steps when working in the 10 V range. In the 5 V range this resolution halves. Due to tolerances, the truly achievable resolution can be slightly lower.

3.6.4.5 Overview of the D-sub socket

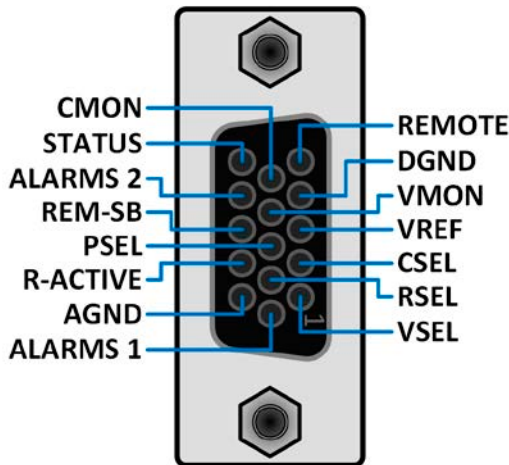

3.6.4.6 Simplified diagram of the pins

	<p>Digital Input (DI)</p> <p>It requires to use a switch with low resistance (relay, switch, circuit breaker etc.) in order to send a clean signal to the DGND.</p>		<p>Analog Input (AI)</p> <p>High resistance input (impedance >40 kΩ) for an operation amplifier circuit.</p>
	<p>Digital Output (DO)</p> <p>A quasi open collector, realized as high resistance pull-up against the internal supply. In condition LOW it can't drive any load, only sink small current, as shown in the diagram with a relay as example.</p>		<p>Analog Output (AO)</p> <p>Output from an operation amplifier circuit, low impedance. See specifications table above.</p>

3.6.4.7 Application examples

a) Switching the DC terminal with pin REM-SB

! A digital output, e.g. from a PLC, may be unable to cleanly pull down the pin as it may not be of sufficiently low resistance. Check the specification of the controlling application. Also see pin diagrams above.

In analog remote control, pin REM-SB is used to switch the DC terminal of the device on and off. This function is also available without analog remote control being active and can on the one hand block the DC terminal from being switched on in manual or digital remote control and on the other hand the pin can switch the DC terminal on or off, but not standalone. See below at "Remote control has not been activated".

! REM-SB cannot serve as a safety stop switch to securely deactivate the DC output in case of emergency! For that an external emergency stop system is required.

It's recommended that a low resistance contact such as a switch, relay or transistor is used to switch the pin to ground (DGND).

Following situations can occur:

- **Remote control has been activated**

During remote control via analog interface, only pin REM-SB determines the states of the DC terminal, according to the level definitions in 3.6.4.3. The logical function and the default levels can be inverted by a parameter in the setup menu of the device. See 3.5.3.1.

! If the pin is unconnected or the connected contact is open, the pin will be HIGH. With setting "Analog interface" -> "REM-SB level" being set to "Normal", it requests to switch the DC terminal on. So when activating remote control, the DC terminal will instantly switch on.

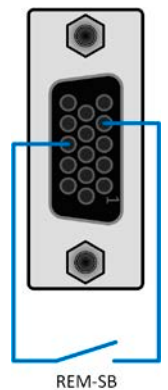

• **Remote control has not been activated**

In this mode of operation pin REM-SB can serve as lock, preventing the DC terminal from being switched on by any means. This results in following possible situations:

DC terminal	+	Level on pin REM-SB	+	Parameter „REM-SB Level“	→ Behavior
is off	+	HIGH	+	Normal	→ The DC terminal isn't locked. It can be switched on by pushbutton "On/Off" (front panel) or via command from digital interface.
		LOW	+	Inverted	
	+	HIGH	+	Inverted	→ The DC terminal is locked. It can't be switched on by pushbutton "On/Off" (front panel) or via command from digital interface. When trying to switch on, a pop-up in the display resp. an error message will be generated.
		LOW	+	Normal	

In case the DC terminal is already switched on, toggling the pin will switch the DC terminal off, similar to what it does in analog remote control:

DC terminal	+	Level on pin REM-SB	+	Parameter „REM-SB Level“	→ Behavior
is on	+	HIGH	+	Normal	→ The DC terminal remains on, nothing is locked. It can be switched on or off by pushbutton or digital command.
		LOW	+	Inverted	
	+	HIGH	+	Inverted	→ The DC terminal will be switched off and locked. Later it can be switched on again by toggling the pin. During lock, pushbutton or digital command can delete the request to switch on by pin.
		LOW	+	Normal	

b) Remote control of current and power

Requires remote control to be activated (pin REMOTE = LOW)

The set values PSEL and CSEL are generated from, for example, the reference voltage VREF, using potentiometers for each. Hence the power supply can selectively work in current limiting or power limiting mode. According to the specification of max. 5 mA load for the VREF output, potentiometers of at least 10 kΩ must be used.

The voltage set value VSEL is directly connected to VREF and will thus be permanently 100%. This also means that the device can only work in source mode.

If the control voltage is fed in from an external source it's necessary to consider the input voltage ranges for set values (0...5 V oder 0...10 V).

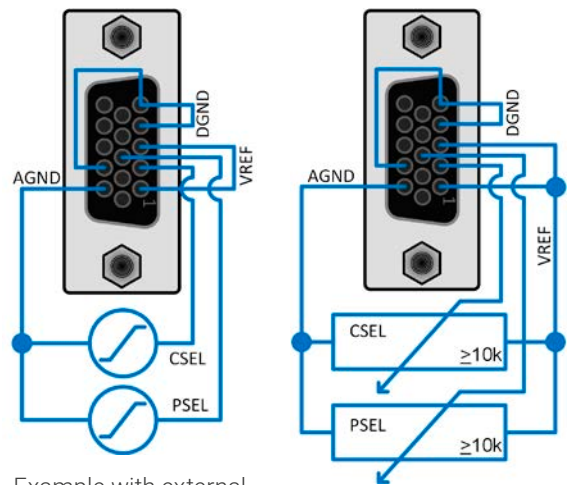

Example with external voltage source

Example with potentiometers

! When using the voltage range 0...5 V the effective resolution of set values and actual values halves.

c) Reading actual values

The AI provides the DC terminal values as current and voltage monitor. These can be read using a standard multimeter or similar.

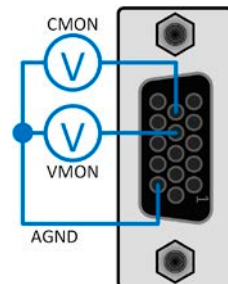

d) Switching between source and sink mode

You can also switch between both modes when remotely controlling the device with the AI. This is done using the voltage set value (VSEL), which then must not be tied to a fixed potential, like shown in example b). Rules:

- If the voltage set value on VSEL (in %, not the level) becomes higher than the actual voltage on the DC terminal, the device will switch to sink mode, no matter if the voltage on the DC terminal is generated by the device or from external
- If the voltage set value becomes lower than the actual voltage, the device will switch to source mode.

e) Determining the actual operation mode between source and sink

The limited number of pins on the AI doesn't allow for a separate signal to indicate sink or source mode. There are basically two ways to determine the actual mode in analog remote control:

- Compare the actual voltage output (VMON) with VSEL and also read the CMON signal -> if the level of VMON is higher than VSEL and CMON isn't zero, then the device is in sink mode, otherwise if VMON is equal to or lower than VSEL, it's in source mode, no matter what the level of CMON is
- Configure pins 9 (VMON) and 10 (CMON), as described in 3.5.3, for **Mode A** or **Mode B** and read both pins; when DC current is flowing in any of both directions, one of the pins will indicate with a level > 0 V.

3.7 Alarms and monitoring

3.7.1 Definition of terms

There is a clear distinction between device alarms (see “3.4. Alarm conditions”), such as overvoltage protection **OVP** or overheating protection **OT**, and user defined events such as **OVD** (overvoltage detection). Whilst device alarms only switch off the DC terminal, user defined events can do more. They can also switch off the DC terminal (**Action = Alarm**), but can alternatively simply give an acoustic signal to make the user aware. The actions driven by **user defined events** can be selected:

Action	Impact	Example
None	User defined event is disabled.	
Signal	On reaching the condition which triggers the event, the action Signal will show a text message in the status area of the display.	
Warning	On reaching the condition which triggers the event, the action Warning will show a text message in the status area of the display and pop up an additional warning message which can be noticed from a bigger distance.	
Alarm	On reaching the condition which triggers the event, the action Alarm will show a text message in the status area of the display with an additional alarm pop-up, and additionally emit an acoustic signal (if activated). Furthermore the DC terminal is switched off. Most of the device alarms are signaled on the analog interface, while all can be queried via the digital interfaces.	

3.7.2 Device alarm and event handling

Important to know:
When switching the DC input (sink mode) of the device off while a current limited source still supplies energy, the output voltage of the source can rise immediately and due to transient times the output voltage can have an overshoot to an unknown level which might trigger the overvoltage alarm (OVP) or the overvoltage supervision event (OVD) of the PSB 10000 in case these thresholds are adjusted to sensitive levels.

A device alarm incident will usually lead to DC terminal switch-off, the appearance of a pop-up in the middle of the display and, if activated, an acoustic signal to make the user aware. An alarm must always be acknowledged.

► **How to acknowledge an alarm in the display (during manual control)**

1. If the alarm is indicated as a pop-up, tap **Acknowledge**.
2. If the alarm has already been acknowledged, but is still displayed in the status area, then first tap the status area to display the pop-up and then **Acknowledge**.

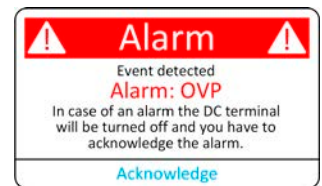

In order to acknowledge an alarm during analog remote control refer to “3.6.4.2. Acknowledging device alarms”. To acknowledge in digital remote control, refer to the external documentation “Programming Guide ModBus & SCPI”.

Some device alarms are configurable, separately for source and sink mode:

Short	Long	Description	Range	Indication
OVP	OverVoltage Protection	Triggers an alarm as soon as the voltage on the DC terminal reaches the defined threshold. The DC terminal will be switched off.	$0 V \dots 1.1 \cdot U_{Nom}$	Display, analog & digital interfaces
OCP	OverCurrent Protection	Triggers an alarm as soon as the current in the DC terminal reaches the defined threshold. The DC terminal will be switched off.	$0 A \dots 1.1 \cdot I_{Nom}$	Display, analog & digital interfaces
OPP	OverPower Protection	Triggers an alarm as soon as the output or input power reaches the defined threshold. The DC terminal will be switched off.	$0 W \dots 1.1 \cdot P_{Nom}$	Display, analog & digital interfaces

These device alarms can't be configured and are based on hardware:



Short	Long	Description	Indication
PF	Power Fail	AC supply over- or undervoltage. Triggers an alarm in case the AC supply is out of specification or when the device is cut from supply, for example when switching it off with the power switch. The DC terminal will be switched off. The condition of the DC terminal after a temporary PF alarm can be determined by the setting DC terminal -> State after PF alarm .	Display, analog & digital interfaces
		 <i>Acknowledging a PF alarm during runtime can only occur approx. 15 seconds after the cause of the alarm has gone. Switching the DC output on again requires another approx. 5 seconds of waiting time.</i>	
OT	OverTemperature	Triggers an alarm in case the internal temperature reaches a certain limit. The DC terminal will be switched off. The condition of the DC terminal after cooling down can be determined by the setting DC terminal -> State after OT alarm .	Display, analog & digital interfaces
MSP	Master-Slave Protection	Triggers an alarm in case the master unit loses contact to any slave unit. The DC terminal will be switched off. The alarm can be cleared by reinitializing the MS system.	Display, digital interfaces
Safety OVP	Safety OverVoltage Protection	Only featured with the 60 V model: Triggers a special OVP alarm in case the voltage on the DC terminal exceeds the rigid threshold of 101% rated voltage. The DC terminal will be switched off. For details refer to section 3.4.6	Display, analog & digital interfaces
SF	Share Bus Fail	Can occur in situations where the Share bus signal is damped too much due to wrong or damaged (short-circuit) BNC cables or simply when at least one of the Share bus connectors is wired to another device while the alarm reporting one isn't configured for master-slave operation. For details also see 3.4.7.	Display, digital interfaces

► **How to configure the thresholds of the adjustable device alarms**

1. While the DC terminal is switched off tap the touch area  on the main screen.
2. In the menu tap on group **Protection**. On the right-hand side of the screen it will list all device alarms with their adjustable thresholds. These are permanently compared to the actual values of voltage, current and power on the DC terminal. Here is also distinguishes between source and sink mode.
3. Set the threshold for the protections relevant to your application if the default value of 110% is unsuitable.

The user also has the possibility of selecting whether an additional acoustic signal will be sounded if an alarm or user defined event occurs.

► **How to configure the alarm sound (also see "3.5.3. Configuration via the menu")**

1. Swipe with your finger up from the bottom edge of the screen or directly tap on the bottom bar:
 
2. The quick menu will open. Tap on  to activate the alarm sound, or on  to deactivate it.
3. Leave the quick menu.

3.7.2.1 User defined events

The monitoring functions of the device can be configured for user defined events. By default, events are deactivated (**Action** set to **None**). Contrary to device alarms, the events only work while the DC terminal is switched on. It means, for instance, that you can't detect undervoltage (UVD) anymore after switching the DC terminal off and the voltage would still be sinking. The following events can be configured independently and separately for sink and source mode:

Event	Meaning	Description	Range
UVD	UnderVoltage Detection	Triggers an event if the DC voltage falls below the defined threshold.	0 V...U _{Nom}
OVD	OverVoltage Detection	Triggers an event if the DC voltage exceeds the defined threshold.	0 V...U _{Nom}
UCD	UnderCurrent Detection	Triggers an event if the DC current falls below the defined threshold.	0 A...I _{Nom}
OCD	OverCurrent Detection	Triggers an event if the DC current exceeds the defined threshold.	0 A...I _{Nom}
OPD	OverPower Detection	Triggers an event if the DC power exceeds the defined threshold.	0 W...P _{Nom}



These events shall not be confused with alarms such as OT and OVP which are for device protection. User defined events can, however, if set to action "Alarm", switch off the DC terminal and thus protect the load, like a sensitive electronic application.

► How to configure user defined events

1. While the DC terminal is switched off tap touch area  on the main screen.
Settings
2. On the left side tap on group **User events**. It will then let you access all user definable events on the right-hand side. The values you can adjust there are thresholds which permanently compared to the actual values of voltage, current and power on the DC terminal while it's on. Here is also distinguishes between source (PS) and sink (EL) mode.
3. Tap on the values to adjust them with the numeric pad popping up. The adjustable range is here not restricted by the adjustment limits. The **Action** for every event is set with a drop-down selector. See "3.7.1. Definition of terms" for the meaning of the actions.



User events are part of the currently selected user profile. Thus, if another user profile or the default profile is loaded, the events could either be differently configured or not at all.

3.8 Locking the control panel (HMI)

In order to avoid the accidental alteration of a value during manual operation the rotary knobs or the touchscreen can be locked so that no alteration of values will be accepted without prior unlocking.

► How to lock the HMI

1. In the main page, tap the padlock symbol  in upper right corner. If the DC terminal is switched on in this moment, the lock is immediately effective.
2. Otherwise the **Lock** screen will appear where you can select to lock the HMI completely or with the exception of the button **On/Off** by enabling **On/Off possible during HMI lock**. Additionally, you can decide to activate the additional **PIN for user interface lock**. The device would later request to enter this PIN every time you want to unlock the HMI.
3. Activate the lock with **Start**. The device will jump back to the main screen and dim it.

1. If an attempt is made to tap the screen or rotate a knob whilst the HMI is locked, a requester appears in the display asking if the lock should be disabled.

► How to unlock the HMI

1. Tap any area on the touchscreen or rotate any knob or press the button "On/Off" (only in full lock).
2. This request pop-up will appear:
The dialog box is rectangular with a white background and a thin border. It contains the text "HMI locked" in the center, flanked by two padlock icons. At the bottom, there is a blue button labeled "Unlock".
3. Unlock the HMI by tapping on **Unlock** within 5 seconds, otherwise the pop-up will disappear and the HMI remains locked. In case the additional PIN code lock has been activated in the **Lock** screen, another requester will pop up, asking you to enter the PIN before it finally unlocks the HMI.

3.9 Locking the adjustment limits and user profiles

In order to avoid the alteration of the adjustment limits (also see "3.5.4. Adjustment limits") by an unprivileged user, the screen with the adjustment limit settings ("Limits") can be locked by a PIN code. This will lock group **Limits** in the **Settings** menu and menu **Profiles** until the lock is removed by entering the correct PIN or, in case it has been forgotten, by resetting the device to factory default.

► How to lock the Limits and Profiles

1. While the DC terminal is switched off, tap the padlock symbol  on the main screen. In case the HMI is locked, it has to be unlocked first. After this, menu page **Lock** will be entered.
2. In the switch next to **Lock limits and profiles with user PIN**.
3. Leave the **Settings** menu.



The same PIN as for the HMI lock is used here. It should be set before activating the Limits lock. See "3.8. Locking the control panel (HMI)"



Be careful to enable the lock if you are unsure what PIN is currently set. In doubt use ESC to exit the menu page. In menu page **Lock** you can define a different PIN, but not without entering the old one.

► How to unlock the Limits and Profiles

1. While the DC terminal is switched off, tap touch area  on the main screen.
Menu
2. In the menu tap on **HMI setup**, then on group **Lock**.
3. In the group tap on "**Unlock limits and profiles**". You will be requested to enter the 4-digit PIN.
4. Deactivate the lock by entering the correct PIN.

3.10 Loading and saving user profiles

The menu **Profiles** serves to select between a default profile and up to 5 user profiles. A profile is a collection of all settings and set values. Upon delivery or after a factory reset all 6 profiles have the same settings and all set values are 0. Values adjusted on the main screen or anywhere else belong to a working profile which can be saved to one of the 5 user profiles. These user profiles or the default profile can then be switched. The default profile is read-only.

The purpose of a profile is to load a set of set values, settings limits and monitoring thresholds quickly without having to readjust these. As all HMI settings are saved in the profile, including language, a profile change can also be accompanied by a change in HMI language.

On calling up the menu page and selecting a profile the most important settings can be seen, but not changed.

► How to save the current values and settings as a user profile:

1. While the DC terminal is switched off, tap touch area  on the main screen.
2. In the main menu tap on **Profiles**.
3. In the next screen (see example to the right) choose between user profiles 1-5, which will show the profile's stored settings for your verification.
4. Tap on **Save/Load** and save the settings into the user profile in the popping up requester "Save profile?" with **Save**.

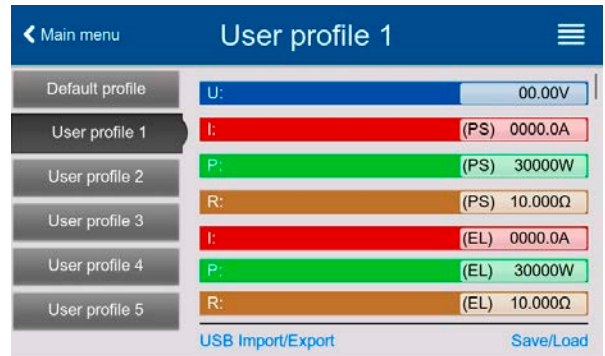

All user profiles also allow to just edit some settings or values stored in the profile. When doing so, the changes either need to be saved to the profile with **Save changes** or discarded with **Cancel** before the profile can be loaded.

Loading a user profile works the same way, but in the requester you would then tap **Load** under **Load profile?**.

Alternatively, you may import the profile or export it as file to a USB stick with **USB Import/Export**.

3.11 The function generator

3.11.1 Introduction

The built-in **function generator** (short: **FG**) is able to create various signal forms and apply these to the set value of either voltage or current.

The standard functions are based on an **arbitrary generator** and directly accessible and configurable using manual control. In remote control, the fully customizable arbitrary generator replicates these functions with sequence points containing 8 parameters each.

Other functions, such as photovoltaics simulation, are based on an **XY generator** that works with a table of 4096 values which are either loaded from a USB stick or calculated based upon adjustable parameters.

The following functions are retrievable, configurable and controllable:

Function	Short description
Sine	Sine wave generation with adjustable amplitude, offset and frequency
Triangle	Triangular wave signal generation with adjustable amplitude, offset, rise and fall times
Rectangular	Rectangular wave signal generation with adjustable amplitude, offset and duty cycle
Trapezoid	Trapezoidal wave signal generation with adjustable amplitude, offset, rise time, pulse time, fall time, idle time
DIN 40839	Simulated automobile engine start curve according to DIN 40839 / EN ISO 7637, split into 5 curve sequences, each with a start voltage, final voltage and time
Arbitrary	Generation of a process with up to 99 freely configurable curve points, each with a start and end value (AC/DC), start and end frequency, phase angle and total duration
Ramp	Generation of a linear rise or fall ramp with start and end values and time before and after the ramp
XY table	XY generator, USB stick loadable current curve (table, CSV)
PV table (PS) PV EN50530 FC table (PS)	Functions to simulate a solar panel (PV function), also according to EN 50530, or fuel cell (FC function), both with table calculation based upon adjustable parameters
Battery test	Battery charge and discharge test with constant or pulsed current, along with Ah, Wh and time counters
MPP tracking	Simulation of the characteristic tracking behavior of solar inverters when seeking to find the maximum power point (MPP) when being connected to typical sources such as solar panels

3.11.2 General

3.11.2.1 Limitations

The function generator is not accessible, neither for manual access nor for remote control, if resistance mode (R mode, also called UIR) is active.

3.11.2.2 Principle

The device features a built-in function generator (short: FG), but the entire unit can't be considered as high power function generator, because its power stages are only post-connected to the FG. Primarily in source mode, the typical characteristics of a voltage and current source remain. Rise and fall times, caused by capacitor charge/discharge, affect the resulting signal on the DC terminal. While the FG is able to generate a sine wave with 10000 Hz, the device will never be able to follow the generated signal 1:1. Source and sink mode will slightly differ from each other regarding the results, while the sink mode will be generally better, because primarily focused on current.

Depiction of principle:

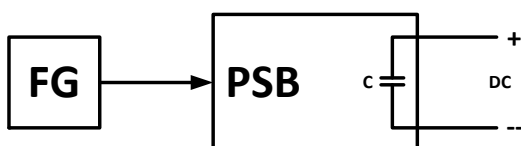

Effect of the DC power stages on functions:

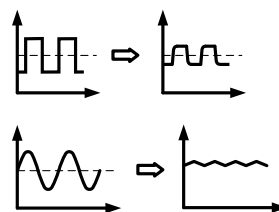

The resulting wave on the DC terminal heavily depends on the frequency resp. period of the selected wave, its amplitude and also the voltage rating of the device. The effect of the capacities on the wave can be partially compensated. In source mode and when running voltage dynamics to which the capacities have the biggest impact on it can help to put an additional load to the DC terminal in order to decrease rise and fall times. This extra load has a positive impact on periodic functions like rectangle or sine wave.

3.11.2.3 Resolution

Amplitudes generated by the arbitrary generator have an effective resolution of approx. 52428 steps. If the amplitude is very low and the time long, the device would generate less steps and set multiple identical values after another, generating a staircase effect. It's furthermore not possible to generate every possible combination of time and a varying amplitude (slope).

3.11.2.4 Possible technical complications

Operation of switching mode power supplies as a voltage source can, when applying a function to the output voltage, lead to damage of the output capacitors due to continuous charging/discharging which causes overheating.

3.11.2.5 Minimum slope / maximum ramp time

Removed since release of KE 3.02 and DR 1.0.2.20 (newer production dates from 03/2022) and 1.0.9 (older production dates until approx. 01/2022).

Ramps or mixed AC/DC functions where the DC offset varies from start to end don't have a minimum slope anymore. The time of a sequence point can now use the full 36000 seconds.

3.11.3 Method of operation

In order to understand how the function generator works and how the values interact, the following should be noted:

The device always works with the three set values U, I and P, also in function generator mode.

The selected function can be used on one set value, U or I, while the other two values are constant and have a limiting effect. Example: in sink mode, a source with 100 V is connected and the sine function applied to the current with an amplitude of 80 A and offset 80 A. The function generator would create a sine wave progression of current between 0 A (min) and 160 A (max), which will result in an input power between 0 W (min) and 16000 W (max). But in case the power would be limited to 12000 W the current would be limited to 120 A and if probed with an oscilloscope it could be viewed being truncated at 120 A and never reach the peak of 160 A.

For an even better understanding how the device works in dynamic operation read following:



- The device also has an integrated electronic load, here called sink, which is supposed to discharge the capacities on the DC terminal of the device when running dynamic voltage changes in source mode, i.e. higher voltage to lower voltage. This requires a certain current and thus power setting, which can and should be adjusted for almost every function described below (values "I (EL)" and "P (EL)"). For safety reasons, the value "I (EL)" is always set to 0 after selecting a function for configuration, which deactivates sink mode.
- The sink current, adjustable as "I (EL)", when being set to > 0 would load an external source, perhaps also discharge capacities in this source and thus this current setting has to be chosen carefully, because it also affects the necessary cross section of cables. Recommendation: set "I (EL)" to at least I_{Peak} of the resulting curve or higher.

Master-slave systems have further characteristics which have to be considered:



At the end of the configuration, after the function has been loaded and the screen shows the main view of the function generator, there are adjustable set values, the so-called "U/I/P limits". These limits are transferred to all slave units of master-slave systems as set values. It's recommended to carefully configure them so the MS system can work as expected and the slaves wouldn't impact the function run in a negative way.

3.11.4 Manual operation

3.11.4.1 Function selection and control

All the functions listed in 3.11.1 can be called on the touch screen, configured and controlled. Selection and configuration are only possible while the DC terminal is switched off.

► How to select a function and adjust parameters

1. While the DC terminal is switched off tap touch area



on the main screen. Note: this icon is locked as long as resistance mode (R mode) is enabled.

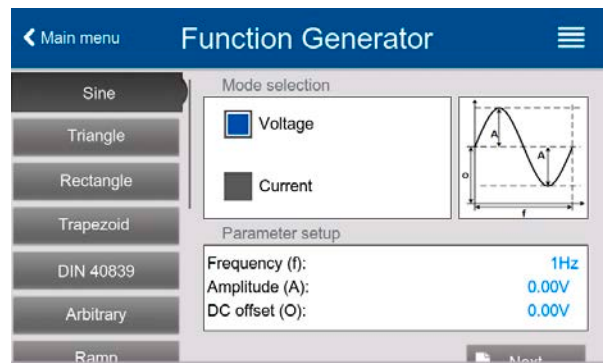

2. In the menu select the desired function by tapping on the list on the left-hand side. Depending on the choice of function there follows a request to which value the function generator is going to be applied, **Voltage** or **Current**.
3. Adjust the parameters as you desire.
4. Adjust the overall limits of voltage, current and power, then continue with .
5. As last part of the configuration, global set values have to be defined which are considered as static values and come into effect before and after the function run. Correct setup here is important, especially when running the function on a master device of a master-slave system.





- When intending to run a function exclusively in sink or in source mode, it's recommended to set the set values (I, P) of the opposite mode to 0.
- The global limits of U, I and P become instantly active when coming to the main screen of the function generator, because the DC terminal is then switched on automatically to settle the start situation. This can be helpful when wanting a function shall not start at 0 V or 0 A. In case the situation requires otherwise, the static values could also be set to 0.

6. Exit the configuration and enter the main function generator screen with .

Setting the various functions and their parameters is described below. After the function generator screen has been reached, the function is ready to run. Before and while the function is running, some global and also some function related values can be adjusted anytime.

► How to start and stop a function

1. The function can be **started** either by tapping  or if the DC terminal is currently switched off by pushing the "On/Off" button on the front.
2. The function can either be **stopped** by tapping  or operating the "On/Off" button. However, there is a difference:
 - a) The  button only stops the function while the DC terminal remains ON with the static values in effect.
 - b) The "On/Off" button stops the function and switches the DC terminal off.

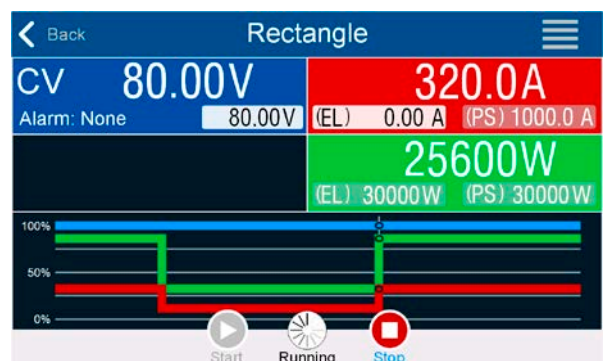

Any device alarm (power fail, overtemperature etc.), protection (OPP, OCP) or event with Action = Alarm stops the function progress automatically, switches off the DC terminal and reports the alarm.

3.11.5 Sine wave function

Restrictions which apply particularly to this function:

- There is no preselection to which of both, source mode and sink mode, the function is applied; the settings decide whether it's "source mode only", "sink mode only" or a mixture of both
- When applying the function to the voltage, the device can only switch to and work in sink mode if the external voltage on the DC terminal is higher than the highest point (offset + amplitude) of the wave and the current setting "I (EL)" is not 0

The following parameters can be configured for a sine function:

Parameter	Range	Description
Frequency (f)	1...10000 Hz	Static frequency of the signal to be generated
Amplitude (A)	0...(rated value - O) of U or I	Amplitude of the signal to be generated
Offset (O)	0... (U _{Nom} - A) - (I _{Nom} - A)...+(I _{Nom} - A)	Offset from the zero point of the mathematical sine curve

Schematic diagram:	Application and result:
	<p>A sine wave signal is generated and applied to the selected set value, e.g. the current (I mode). Depending on the adjusted parameters the device can apply the wave either solely to sink mode or to source mode, but also to both with automatic switchover at zero point. The scheme on the left depicts the "mixed mode" run (yellow = source mode active, green = sink mode active). While the amplitude is always an absolute value, the offset can be positive or negative (I mode only).</p> <p>For calculating the maximum power the current amplitude and the offset value have to be added.</p> <p>Example: a voltage of 100 V is set. The parameters for the sin(I) function are: amplitude of 80 A and offset of +50 A. The resulting maximum power when reaching the highest point of the sine wave then is $(80 \text{ A} + 50 \text{ A}) * 100 \text{ V} = 13000 \text{ W}$ for the source part and when reaching the lowest point (sink part) it will be $(50 \text{ A} - 80 \text{ A}) * 100 \text{ V} = -3000 \text{ W}$.</p>

3.11.6 Triangular function

Restrictions which apply particularly to this function:

- There is no preselection to which of both, source mode and sink mode, the function is applied; the settings decide whether it's "source mode only", "sink mode only" or a mixture of both
- When applying the function to the voltage, the device can only switch to and work in sink mode if the external voltage on the DC terminal is higher than the highest point (offset + amplitude) of the wave and the current setting "I (EL)" is not 0

The following parameters can be configured for a triangular function:

Parameter	Range	Description
Amplitude (A)	0...(rated value - Offs) of U or I	Amplitude of the signal to be generated
Offset (O)	0... (U _{Nom} - A) - (I _{Nom} - A)...+(I _{Nom} - A)	Offset, based on the foot of the triangular wave
Time t1	0.1 ms...36,000,000 ms	Rising edge time Δt of the triangular wave signal
Time t2	0.1 ms...36,000,000 ms	Falling edge time Δt of the triangular wave signal

Schematic diagram:	Application and result:
	<p>A triangular wave signal for use on the current or voltage is generated. The positive and negative slope times can be set independently.</p> <p>The offset shifts the signal on the Y axis.</p> <p>The sum of the intervals t_1 and t_2 gives the cycle time and its reciprocal is the frequency.</p> <p>Example: a frequency of 10 Hz is required and would lead to periodic duration of 100 ms. This 100 ms can be freely allocated to t_1 and t_2, e.g. 50 ms:50 ms (isosceles triangle) or 99.9 ms:0.1 ms (right-angled triangle or sawtooth).</p>

3.11.7 Rectangular function

Restrictions which apply particularly to this function:

- There is no preselection to which of both, source mode and sink mode, the function is applied; the settings decide whether it's "source mode only", "sink mode only" or a mixture of both
- When applying the function to the voltage, the device can only switch to and work in sink mode if the external voltage on the DC terminal is higher than the highest point (offset + amplitude) of the wave and the current setting "I (EL)" is not 0

The following parameters can be configured for a rectangular function:

Parameter	Range	Description
Amplitude (A)	0...(rated value - Offs) of U or I	Amplitude of the signal to be generated
Offset (O)	$0 \dots (U_{Nom} - A)$ $-(I_{Nom} - A) \dots +(I_{Nom} - A)$	Offset, based on the foot of the rectangular wave
Time t1	0.1 ms...36,000,000 ms	Time (pulse width) of the upper level (amplitude)
Time t2	0.1 ms...36,000,000 ms	Time (pause width) of the lower level (offset)

Schematic diagram:	Application and result:
	<p>A rectangular or square wave signal for use on the current or voltage is generated. The intervals t_1 and t_2 define how long the value of the amplitude (pulse) and how long the value of the offset (pause) are effective.</p> <p>The offset shifts the signal on the Y axis.</p> <p>Intervals t_1 and t_2 can be used to define a duty cycle. The sum of t_1 and t_2 gives the period and its reciprocal the frequency.</p> <p>Example: a rectangular wave signal of 25 Hz and a duty cycle of 80% are required. The sum of t_1 and t_2, the period, is $1/25 \text{ Hz} = 40 \text{ ms}$. For a duty cycle of 80% the pulse time (t_1) is $40 \text{ ms} \cdot 0.8 = 32 \text{ ms}$ and the pause time (t_2) is 8 ms</p>

3.11.8 Trapezoidal function

Restrictions which apply particularly to this function:

- There is no preselection to which of both, source mode and sink mode, the function is applied; the settings decide whether it's "source mode only", "sink mode only" or a mixture of both
- When applying the function to the voltage, the device can only switch to and work in sink mode if the external voltage on the DC terminal is higher than the highest point (offset + amplitude) of the wave and the current setting "I (EL)" is not 0

The following parameters can be configured for a trapezoidal function:

Parameter	Range	Description
Amplitude (A)	0...(rated value - Offset) of U or I	Amplitude of the signal to be generated
Offset (O)	0... ($U_{Nom} - A$) - ($I_{Nom} - A$)...+ ($I_{Nom} - A$)	Offset, based on the foot of the trapezium
Time t1	0.1 ms...36,000,000 ms	Time for the positive slope of the trapezoidal wave signal.
Time t2	0.1 ms...36,000,000 ms	Time for the top value of the trapezoidal wave signal.
Time t3	0.1 ms...36,000,000 ms	Time for the negative slope of the trapezoidal wave signal.
Time t4	0.1 ms...36,000,000 ms	Time for the base value (=offset) of the trapezoidal wave signal

Schematic diagram:	Application and result:
	<p>Same as with other functions the generated signal can be applied to the set value of voltage (U mode) or to the current (I mode). The slopes of the trapezium can be varied by adjusting the times for rise and fall separately.</p> <p>The periodic duration and repetition frequency are the result of the four adjustable time values. With suitable settings the trapezium can be deformed to two triangular or two rectangular pulses. It has, therefore, universal use.</p>

3.11.9 DIN 40839 function

This function is based on the curve defined in DIN 40839 / EN ISO 7637 (test impulse 4), and is only applicable to voltage. It shall replicate the progress of automobile battery voltage during engine starting. The curve is divided into 5 parts (see diagram below) which each have the same parameters. The standard values from the DIN are set already as default values for the five sequences.

Typically, this function is used in source mode, but can also be run in sink mode if the external voltage on the DC terminal is higher than the highest point (offset + amplitude) of the wave and the external source can't deliver more current than adjusted for sink mode (I sink). Else the device could regulate the voltage values resulting from the curve. The global current set values are used to explicitly define in what operation mode the function shall run. The following parameters can be configured for the single sequence points or the entire function:

Parameter	Range	Seq	Description
Start	0... U_{Nom}	1-5	Start voltage of the ramp in part 1-5 (sequence point)
Uend	0... U_{Nom}	1-5	End voltage of the ramp in part 1-5 (sequence point)
Time	0.1 ms...36,000,000 ms	1-5	Time of the ramp
Cycles	0 / 1...999	-	Number of times to run the entire curve (0 = infinite)
Time t1	0.1 ms...36,000,000 ms	-	Time after cycle before repetition (cycle > 1)
U(Start/End)	0... U_{Nom}	-	Voltage setting before and after the function run
I/P (PS)	0... I_{Nom}/P_{Nom}	-	Set values of current and power for source mode. If either I=0 or P=0, the device would only work in sink mode
I/P (EL)	0... I_{Nom}/P_{Nom}	-	Set values of current and power for sink mode. If either I=0 or P=0, the device would only work in source mode

Schematic diagram:	Application and result:
	<p>If the function is set up to run in source mode, the built-in load function acts as a sink and ensures the quick output voltage drop as required for some parts of the curve, allowing the output voltage progress to follow the DIN curve.</p> <p>The curve conforms to test impulse 4 of the DIN. With suitable settings, other test impulses can be simulated. If the curve part in sequence point 4 should contain a sine wave instead, then these 5 sequences would have to be set up for the arbitrary generator.</p> <p>The global start (and end) voltage is adjustable as parameter "U(Start/end)" in the menu page "U/I/P Limits". It does not modify the voltage settings in the single sequence points, but it should match the start voltage setting (U start) of sequence point 1.</p>

3.11.10 Arbitrary function

The arbitrary (freely definable) function or function generator offers the user a wider scope of options. There are 99 curve segments (here: sequence points) available for use on either current (I) or voltage (U), all of which have the same set of parameters but can be differently configured, so that a complex function curve can be "constructed". An arbitrary number out of the 99 sequence points can run in a sequence point block and this block can then be repeated up to 999 times or infinitely. Since the function must be assigned to either current or voltage, mix assignments of sequence point to both is not possible.

The arbitrary curve can overlay a linear progression (DC) with a sine curve (AC) whose amplitude and frequency is shaped between start and end. When both, start frequency and end frequency, are 0 Hz the AC overlay has no impact and only the DC part is effective. Each sequence point is allocated a sequence point time in which the AC/DC curve from start to end will be generated.

The following parameters can be configured for each sequence point in the arbitrary function:

Parameter	Range	Description
AC start AC end	-50%...+50% I_{Nom} or 0%...50% U_{Nom}	Start and end amplitude of the sinusoidal AC part
DC start	$\pm(\text{AC start} \dots (\text{rated value} - \text{AC start}))$	Start level (offset) of the DC part
DC end	$\pm(\text{AC end} \dots (\text{rated value} - \text{AC end}))$	End level (offset) of the DC part
Start frequency	0 Hz...10000 Hz	Start frequency of the sinusoidal AC part
End frequency	0 Hz...10000 Hz	End frequency of the sinusoidal AC part
Angle	0°...359°	Start angle of the sinusoidal AC part
Time	0.1 ms...36,000,000 ms	Time setting for the selected sequence point



The sequence point time ("Time") and the start and end frequency are related. The minimum value for $\Delta f/s$ is 9.3. Thus, for example, a setting of start frequency = 1 Hz, end frequency = 11 Hz and time = 5 s would not be accepted as $\Delta f/s$ is only 2. A time of 1 s would be accepted or, if the time remains at 5 s, then an end frequency = 51 Hz must be set.



The amplitude change between start and end is related to the sequence time. A minimal change over an extended time is not possible and in such a case the device will report an inapplicable setting.

After the settings for the selected sequence point have been defined, further points can be configured. Further down below there are some global settings for the arbitrary function:

Parameter	Range	Description
Cycles	0 / 1...999	Number of cycles to run the sequence point block (0 = infinite)
Start sequence	1... End sequence	First sequence point in the block
End sequence	Start sequence ...99	Last sequence point in the block

After continuing with  there are global set values to define as last part of the function generator setup.

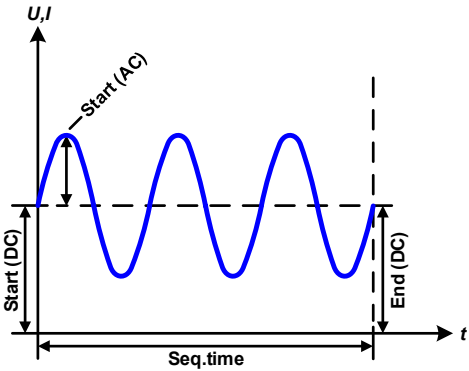
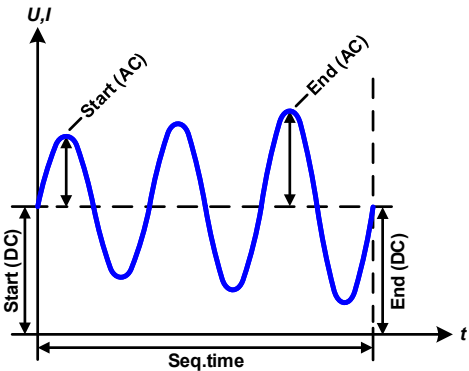
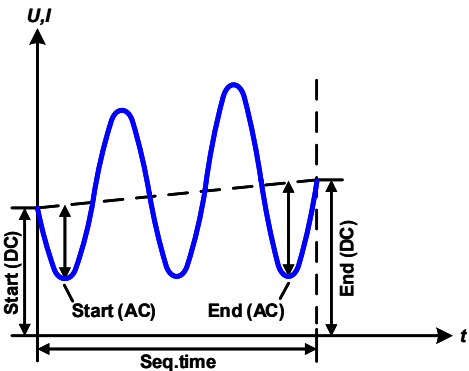
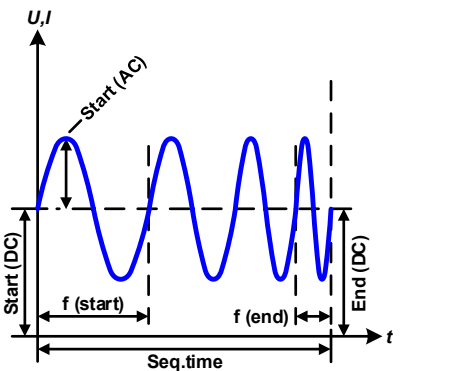
Schematic diagram:	Applications and results:
	<p>Example 1: Focusing 1 cycle of 1 sequence point:</p> <p>DC values for start and end are the same, also the AC amplitude. With a frequency >0 Hz a sine wave progression of the set value is generated with a defined amplitude, frequency and Y axis offset (DC values for start and end).</p> <p>The number of sine waves per cycle depends on the sequence point time and the frequency. If the time was 1 s and the frequency 1 Hz, there would be exactly one sine wave. If the time was 0.5 s at the same frequency, there would only be a half sine wave.</p>
	<p>Example 2: Focusing 1 cycle of 1 sequence point:</p> <p>The DC values at start and end are the same but those of the amplitude aren't. The end value is higher than the start value so the amplitude increases with each new half sine wave continuously over the sequence point time. This, of course, only if time and frequency allow for multiple waves to be created. For instance, with $f=1$ Hz and time = 3 s, three full waves would be generated, if the angle is 0°, and reciprocally the same for $f=3$ s and time=1 s.</p>
	<p>Example 3: Focusing 1 cycle of 1 sequence point:</p> <p>The DC values at start and end are not equal, as well as the AC start and end values. In both cases the end value is higher than the start value so that offset increases over time, but also the amplitude with each new half sine wave.</p> <p>Additionally, the first sine wave starts with a negative half wave because the angle has been set to 180°. The start angle can be shifted at will in steps of 1° between 0° and 359°.</p>
	<p>Example 4: Focusing 1 cycle of 1 sequence point:</p> <p>Similar to example 1 but with a different end frequency. Here this is shown as higher than the start frequency. This impacts the period of the sine waves such that each new wave will be shorter over the total span of the sequence time.</p>

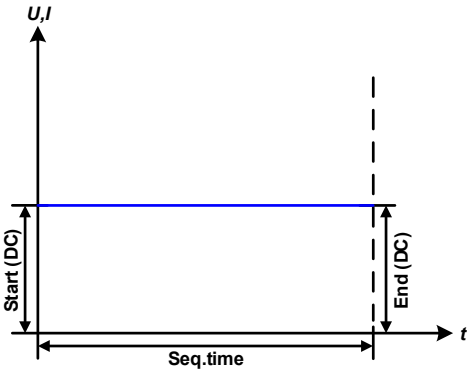
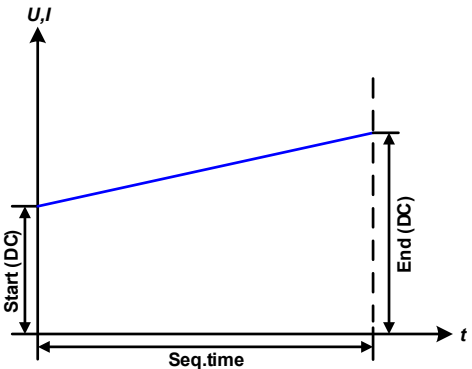
Schematic diagram:	Applications and results:
	<p>Example 5: Focusing 1 cycle of 1 sequence point: Similar to example 1 but with a start and end frequency of 0 Hz. Without a frequency, no sine wave part (AC) will be generated and only the DC settings will be effective. A ramp with a horizontal progression would result.</p>
	<p>Example 6: Focusing 1 cycle of 1 sequence point: Similar to example 1 but with a start and end frequency of 0 Hz. Without a frequency no sine wave part (AC) will be generated and only the DC settings will be effective. Here the DC start and end values are unequal and a steadily increasing ramp would result.</p>

By linking together a number of differently configured sequence points, complex progressions can be created. Smart configuration of the arbitrary generator can be used to match triangular, sine, rectangular or trapezoidal wave functions and thus, e.g. a sequence of rectangular waves with differing amplitudes or duty cycles could be produced.

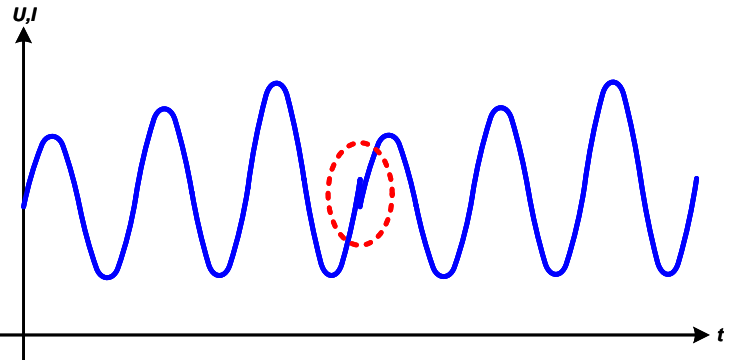
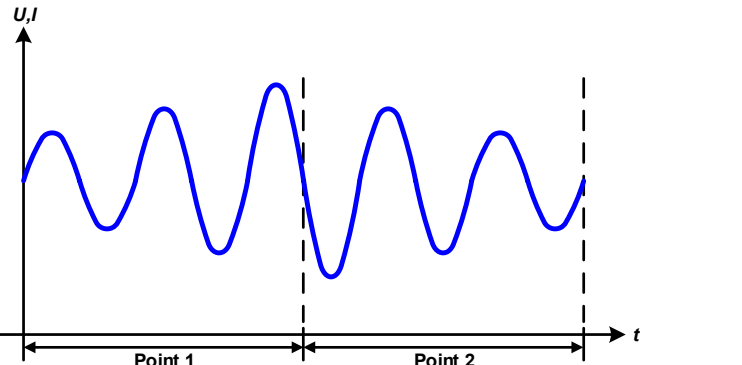
Schematic diagram:	Applications and results:
	<p>Example 7 Focusing 2 cycles of 1 sequence point: One sequence point, configured as in example 3, is run. Since the settings define that the end offset (DC) is higher than the start, the second run will revert to the same start level as the first, regardless of the signal level at the end of the first run. This can produce a discontinuity in the total progression (marked in red) which may only be compensated with a careful choice of settings.</p>
	<p>Example 8 Focusing 1 cycle of 2 sequence points: Two sequence points run consecutively. The first one generates a sine wave with increasing amplitude, the second one with a decreasing amplitude. Together they produce a progression as shown to the left. In order to ensure that the wave peak in the middle occurs only once, the first sequence point must end with a positive half wave and the second one start with a negative half wave as shown in the diagram.</p>

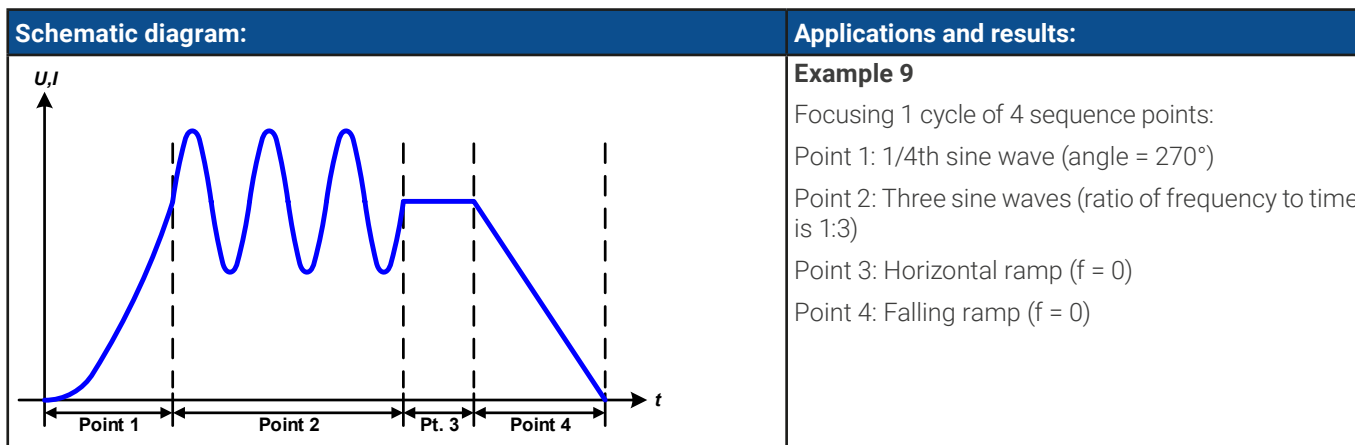

3.11.10.1 Loading and saving the arbitrary function

The 99 sequence points of the arbitrary function, which can be manually configured with the control panel of the device and which are applicable either to voltage (U) or current (I), can be saved to or loaded from a common USB stick via the front side USB port. Generally, all 99 points are saved or loaded at once using a text file of type CSV which represents a table of values.

In order to load a sequence table for the arbitrary generator, following requirements have to be met:

- The table must contain exactly 99 rows with 8 subsequent values (8 columns) and must not have gaps
- The column separator (semicolon, comma) must be as selected by menu parameter **USB logging -> Log file separator format**; it also defines the decimal separator (dot, comma)
- The files must be stored inside a folder called HMI_FILES which has to be in the root of the USB stick
- The file name must always start with WAVE_U or WAVE_I (not case-sensitive)
- All values in every row and column have to be within the specified range (see below)
- The columns in the table have to be in a defined order which must not be changed

Following value ranges are given for use in the table, related to the manual configuration of the arbitrary generator (column headers like in Excel):

Column	Connected to HMI parameter	Range
A	AC start	See table in "3.11.10. Arbitrary function"
B	AC end	See table in "3.11.10. Arbitrary function"
C	Start frequency	0..10000 Hz
D	End frequency	0..10000 Hz
E	Angle	0...359°
F	DC start	See table in "3.11.10. Arbitrary function"
G	DC end	See table in "3.11.10. Arbitrary function"
H	Time	100...36.000.000.000 µs (36 billion)

For details about the parameter and the arbitrary function refer to "3.11.10. Arbitrary function".

Example CSV:

	A	B	C	D	E	F	G	H
1	20,00	30,00	5	5	90	50,00	50,00	5000000
2	30,00	20,00	5	5	90	50,00	50,00	3000000
3	0,00	0,00	0	0	0	0,00	0,00	1000
4	0,00	0,00	0	0	0	0,00	0,00	1000
5	0,00	0,00	0	0	0	0,00	0,00	1000
6	0,00	0,00	0	0	0	0,00	0,00	1000

The example shows that only the first two sequence points are configured, while all others are set to default values. The table could be loaded as WAVE_U or WAVE_I when using, for example, the model PSB 10080-1000 4U, because the values would fit both, voltage and current. The file naming, however, is unique. A filter prevents you from loading a WAVE_I file after you have selected **Arbitrary --> U** in the function generator menu. The file would not be listed at all.

► **How to load a sequence point table from a USB stick:**

1. Do not plug the USB stick yet or remove it.

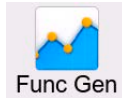

2. While the DC terminal is switched off, tap on **Func Gen** to access the function selection menu. There tap on group **Arbitrary** which will show the settings as shown in the screenshot to the right.

3. Swipe up to go down to the **Sequence setup** part and tap on **Import/Export**, then on **Load** and follow the instructions. If the file open dialog can at least list one compatible file, it will be listed for selection. Select your desired table.

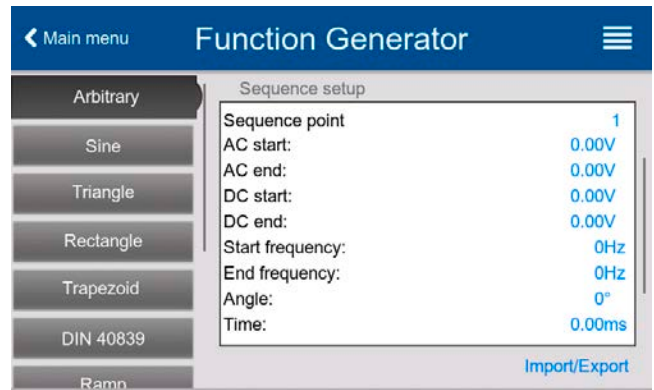

4. To finally load the file, tap on . The selected file is then checked for validity and loaded. In case of format errors, a message will be shown on screen. The file would have to be checked and tried again.

► **How to save a sequence point table to a USB stick:**

1. Do not plug the USB stick yet or remove it.



2. While the DC terminal is switched off, tap on **Func Gen** to access the function selection menu. There tap on group **Arbitrary** which will show the settings as shown in the screenshot to the right.

3. Swipe up to go down to the **Sequence setup** part and tap on **Import/Export**, then on **Save** and follow the instructions. In the file open dialog you can either select an existing file, if at least one compatible file is listed, or you can create a new one by not selecting any file.

4. Save the file, new or overwriting, with .

3.11.11 Ramp function

Restrictions which apply particularly to this function:

- There is no preselection to which of both, source mode and sink mode, the function is applied; the settings decide whether it's "source mode only", "sink mode only" or a mixture of both
- When applying the function to the voltage, the device can only switch to and work in sink mode if the external voltage on the DC terminal is higher than the highest point (offset + amplitude) of the wave and the current setting "I (EL)" is not 0

The following parameters can be configured for a ramp function:

Parameter	Range	Description
Start End	0...U _{Nom} OR -I _{Nom} ...+I _{Nom}	Start/end point of the ramp. Both values can be equal or different, which then results in either a rising, falling or horizontal ramp
Time t1	0.1 ms...36,000,000 ms	Time before ramp-up or ramp-down of the signal.
Time t2	0.1 ms...36,000,000 ms	Ramp-up or ramp-down time

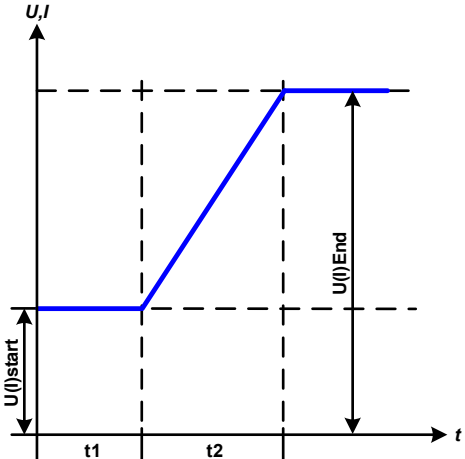

10 h after reaching the ramp end, the function will stop automatically (i.e. I = 0 A, in case the ramp was assigned to the current), unless it has been stopped manually before.

Schematic diagram:	Application and result:
	<p>This function generates a rising, falling or horizontally running ramp between the start and end values over time t_2. Time t_1 creates a delay before the ramp starts.</p> <p>The function runs once and stops at the end value. To have a repeating ramp, the Trapezoid function would have to be used instead (see 3.11.8).</p> <p>Important to consider are the static values of U or I which define the start level before the ramp generation. It's recommended that the corresponding static value is set equal to value Start, unless the load at the DC output (source mode) shall not be provided with a voltage before the actual start of the ramp (time t_1) or the external source shall not yet be loaded with a current in sink mode. In that case the static value should be set to zero.</p>

3.11.12 IU table function (XY table)

The IU function offers the user the possibility to set a DC current dependent on the voltage being present on the DC terminal. This works in source (PS) or sink (EL) mode. The function is driven by a table with exactly 4096 values, which are distributed over the range 0...125% U_{Nom} of actual voltage on the DC terminal. However, because of the upper limit of 102% of the rated current only the first 3342 values in the XY table are effective.

The table can either be uploaded from a USB stick through the front side USB port or via remote control (ModBus protocol or SCPI). The function is defined as:

IU function: $I = f(U) \rightarrow$ the device works in CC mode (if source operation, then with a load in CV mode)



Upload of a table from a USB stick must use text files in CSV format (*.csv). Plausibility is checked when loading, i.e. values not too high, number of values correct etc. which may abort loading when errors are found.



The 4096 values in the table are only checked for size and count. If all the values were to be graphically plotted into a curve it could include huge step changes in the current. This could lead to complications for the connected load or source if, for example, the internal voltage measurement swings slightly so that the current jumps back and forth between a few entries in the table which, in the worst case, could bounce between 0 A and the maximum current.

3.11.12.1 Loading IU tables from USB stick

The so-called IU tables can be loaded from a file via a standard USB stick that is formatted in FAT32. In order to load the file, it has to meet following specifications:



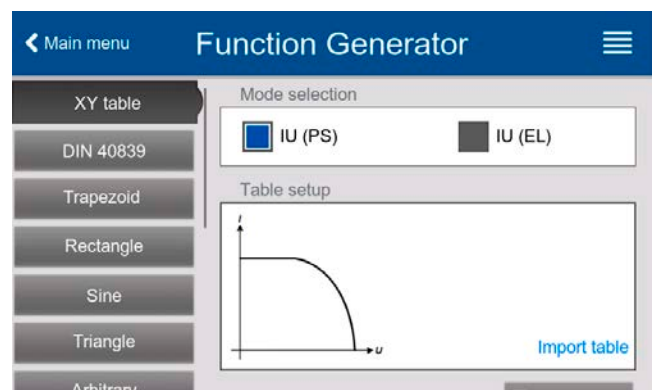

- The file name always begins with IU (not case-sensitive)
- The file must be a text file of type Excel CSV and must only contain one column with exactly 4096 values without gaps
- Values with decimal places must use decimal separator that matches the selection in the general setting **Log file separator format**, which also defines the decimal separator between dot and comma (US default should be dot)

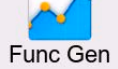

- No value may exceed the rated current of the device model. For example, if you have a 420 A model, none of the 4096 values must be higher than 420 A (the adjustment limits from the device's front panel do not apply here)
- The file(s) has/have to be put inside a folder named HMI_FILES in the root path of the stick

If these specifications are not met, the device won't accept the file and put out an error message in the display. The USB stick may contain multiple IU files with different names and list them for the selection of one.

► How to load an IU table from a USB stick:

1. While the DC terminal is switched off, open the function selection menu by tapping on , then select group **XY table**.
2. In the right-hand part select to run the function in either sink mode with **IU table (EL)** or select **IU table (PS)** to run the function in source mode.
3. Insert the USB stick, if not already done, then tap on **Import table** and in the file selector coming up select the table you want to load and confirm with . In case the file is not accepted for any of the above listed reasons, correct the file format and content, then try again.
4. Tap  to proceed to the next screen where you can adjust the global set values.
5. Finally proceed to the main function screen with , to start and control the function (also see "3.11.4.1. Function selection and control").

3.11.13 Simple PV (photovoltaics) function

3.11.13.1 Preface

This function runs exclusively in source mode (PS) and uses the integrated XY generator to have the power supply simulate solar panels or cells with certain characteristics by calculating an IU table from four typical parameters.

While the function is running, the user can adjust a 5th parameter called **Irradiance** to simulate different light situations.

The most important characteristics of a solar cell are:

- the short-circuit current (I_{SC}), the maximum current at almost 0 V
- the open circuit voltage (U_{OC}), which almost reaches its maximum value even in low light situations
- the maximum power point (MPP), at which the solar panel can provide the maximum output power, defined by U_{MPP} and I_{MPP}

The voltage of the MPP (here: U_{MPP}) lies typically 20% below U_{OC} , the current of the MPP (here: I_{MPP}) lies typically 10% below I_{SC} . In case there are no definite values for the simulated solar cell available, **Impp** and **Umpp** can be set to these typical values. The device limits the I_{MPP} value to I_{SC} as upper limit, the same applies to U_{MPP} and U_{OC} .

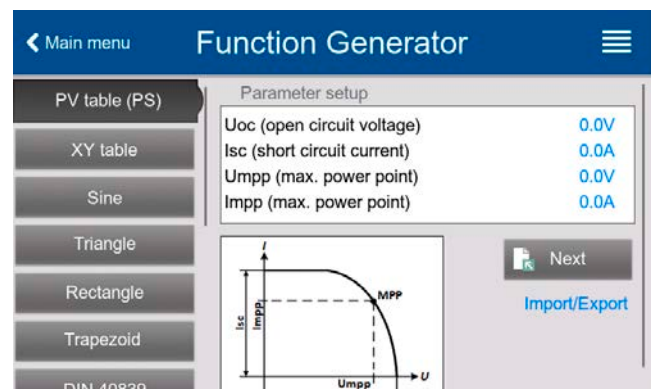

3.11.13.2 Safety notices



Due to high capacitance on the DC terminal of some models, not every available solar inverter can be operated without problems. Check the technical specifications of the solar inverter and probably contact the inverter's manufacturer for an evaluation.

3.11.13.3 Usage

In the PV function, which is based upon the XY generator and an IU table, the MPP (maximum power point) is defined by the two adjustable parameters **Umpp** and **Impp** (also see diagram below). These parameters are usually stated in data sheets of solar panels and have to be entered here.

The following parameters can be set for the PV function:

Parameter	Range	Description
Uoc	Umpp ...rated device voltage	Open circuit voltage at no load
Isc	Impp ...rated device current	Short-circuit current at max. load and low voltage
Umpp	0 V... U_{oc}	DC output voltage of the MPP
Impp	0 A... I_{sc}	DC output current of the MPP

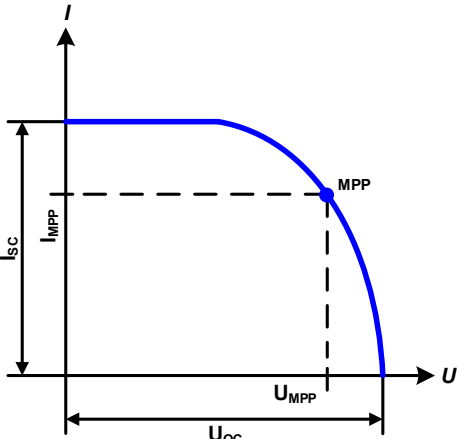
Schematic diagram:	Application and result:
	<p>Adjust all four parameters on screen to the desired values. Whether the calculated IU and P curves which result from those values make sense or not can be verified with tools which can visualize the curve data, such as EA Power Control (only with unlocked Function Generator app) where you could enter the same values and have the curve visualized upon button click.</p> <p>While the simulation is running, the user can see from the actual values (voltage, current, power) of the DC output, where the operating point of the power supply resp. of the simulated solar panel is. The adjustable value Irradiance (0%...100% in 1% steps, see screenshot below) helps to simulate different light situations from darkness (no power output) to the minimal amount of light that is required to have the panel provide full power.</p>

► How to configure the PV table

1. In the function generator menu swipe to find group **PV table (PS)** and tap it.
2. Adjust the four parameters as required for the simulation.
3. Do not forget to adjust the global limits for voltage and power in the next screen. The voltage (U) setting is automatically set as high as U_{oc} and should not be lower, but can be higher.
4. Proceed to the main function screen with  **Next**. Contrary to other functions, the DC output is not automatically switched on, because then the function would immediately. The function is only started when the user switches the DC output on.

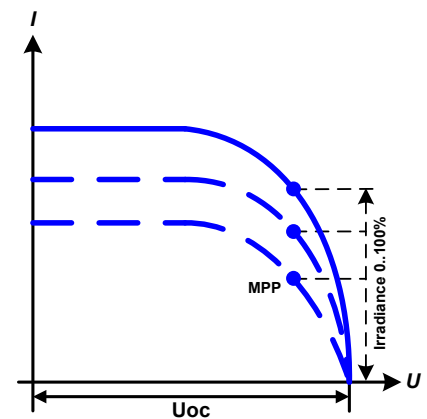

From the main function generator screen, you can go back to the first screen of PV table function and use a formerly locked **Import/Export** action button to save the calculated table to a USB stick. In order to do so, follow the on-screen instructions. The table can be used to analyze/visualize the values in Excel or similar tools.

► How to work with the PV table function

1. With an appropriate load connected, for example a solar inverter, start the function.
2. Adjust value **Irradiance** with any rotary knob or per touch input between 100% (default) and 0%, in order to reproduce different light situations for the simulated panel. The actual values on the display indicate the working point and can show whether the simulation has arrived at the MPP or not.
3. Stop the function run anytime by the stop button or by switching off the DC output.

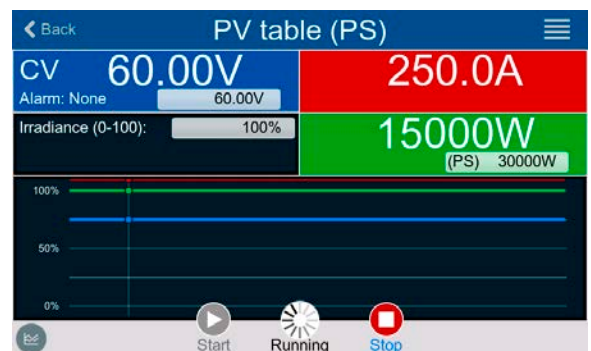

3.11.14 FC table function (fuel cell)

3.11.14.1 Preface

The FC table function is used to simulate the characteristics of voltage and current of a fuel cell. This is achieved by setting up some parameters which define points on a typical fuel cell curve, which is then calculated as UI table and passed to the internal function generator.

The user has to adjust value for four support points. The device will request to enter them step by step, indicating the actual point on screen with small graphics. When finished, these points will be used to calculate the curve.

Generally, following rules apply when setting up those values:

- $U_{OC} > U_{Point2} > U_{Point3} > U_{Point4}$
- $I_{SC} > I_{Point3} > I_{Point2} > I_{Point1}$
- Values of zero are not accepted

In order to express the rules in a simplified way: the voltage has to decrease from point 1 to point 4, while the current has to increase. In case the rules are not followed, the device will reject the settings with an error and reset them to 0.

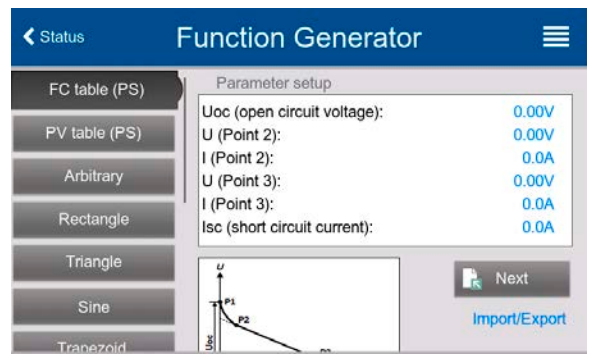

3.11.14.2 Usage

The following parameters can be set for the FC table function:



Parameter	Range	Description
Point 1: Uoc	0 V... U_{Nom}	Maximum voltage of the cell (open circuit voltage at no load)
Points 2+3: U	0 V... U_{Nom}	Voltage and current define the position of these two points in the XY coordinate system, which represent two supporting points on the curve to be calculated
Points 2+3: I	0 A... I_{Nom}	
Point 4: Isc	0 A... I_{Nom}	Maximum output current of the fuel cell (short-circuit situation)
U	0 V... U_{Nom}	Global voltage limit, should be $\geq U_{oc}$
P	0 W... P_{Nom}	Global power limit, mustn't be 0 to have the function run as expected



All these parameters all freely adjustable and it may occur that the curve calculation fails. In such a situation, the device would show an error. Then you are required to check the settings, adjust and try again.

Schematic diagram:	Application and result:
	<p>After setting up the four supporting points Point 1 thru Point 4, whereas Point 1 is defined by U_{oc} and 0 A and Point 4 is defined by I_{sc} and 0 V, the device will calculate the function as IU table and load it to the XY generator.</p> <p>Depending on the load current, which can be between 0 A and I_{sc}, the device should set a variable output voltage between 0 V and U_{oc}, resulting in a curve similar to the one depicted to the left.</p> <p>The slope between Point 2 and Point 3 is depending on the values adjusted for Point 2 and Point 3 and can be freely modified as long as Point 3's voltage is lower than the one of Point 2 and Point 3's current is higher than the one of Point 2.</p>

► How to configure the FC table

1. In the function generator menu tap on group **FC table (PS)**.
2. Adjust the parameters of the four supporting points, as required for the simulation.
3. Do not forget to adjust the global limits for voltage and power in the next screen which reach by tapping on  Next.
4. After setting up everything proceed to the main function generator screen with  Next. After the function has been loaded to the internal XY generator, the simulation is ready to start.

From the main function generator screen, you can go back to the first screen of FC table configuration and use a formerly locked **Import/Export** -> **Save** action button, to save the calculated table to USB stick. In order to do so, follow the on-screen instructions. The table can be used to analyze the values or to visualize it in Excel or similar tools.

► How to work with the FC table function

1. With an appropriate load connected, for example a DC-DC converter, start the function by switching the DC output on.
2. The output voltage will be set depending on the load current, which is defined by the connected load, and will decrease with increasing current. Without any load, the voltage will rise to the adjusted Uoc value.
3. Stop the function run anytime by the stop button or by switching off the DC output.

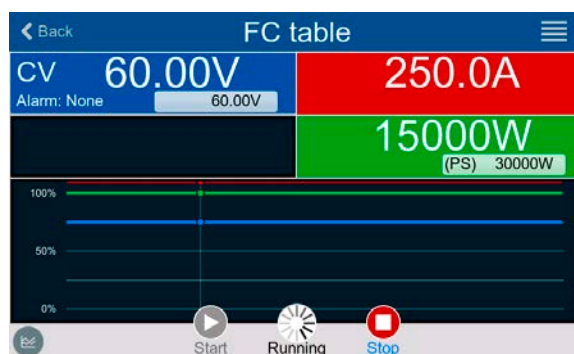

3.11.15 Extended PV function according to EN 50530

3.11.15.1 Introduction

This extended PV table function according to norm EN 50530 is used to simulate solar panels in order to test and rate solar inverters. It's also based on the XY generator, same as the simple PV table function from 3.11.13, but enables more specific tests and evaluations due to adjustable parameters. Which parameters are available is explained below. The device can, however, only calculate and run the PV curve. Evaluation of a solar inverter, as described in the norm paper, is only possible with our software **EA Power Control**. It will, amongst other result data, determine the inverter's efficiency.

The impact of the parameters on the PV curve and the simulation is described in the norm paper of EN 50530, which users can refer to in case more detailed description is required. This section only deals about configuration and control of the PV simulation.

3.11.15.2 Differences to the basic PV function

The extended PV function has five additional or different characteristics compared to the simple PV function:

- The simulation distinguishes between a single test run and an automatic test run, called day trend, which is based upon a user-defined curve built from up to 100,000 points
- There are two invariable and one variable panel technology available to choose from
- There are more parameters available to adjust during runtime
- It allows for data recording during runtime and to save the data either to USB stick or read via digital interface
- It allows to select between two different parameter sets to adjust during runtime

3.11.15.3 Technologies and technology parameters

When configuring the PV simulation it's required to select the solar panel technology to simulate. The technologies **cSI** and **Thin film** are invariable in their parameters, while technology **Manual** is variable in all parameters, but within specific limits. This allows for the variation of the simulation and when copying the fixed parameter values from **cSi** or **Thin film** to **Manual**, it even enables their variation as well.

One advantage of the invariable technologies is that their technology parameters are automatically set to their defined defaults in the configuration procedure.

Overview of the technology parameters used in the PV curve calculation and their defaults:

Abbr.	Name	Manual	cSI	Thin film	Unit
FFu	Fill factor for voltage	>0...1 (0.8)	0.8	0.72	-
FFi	Fill factor for current	>0...1 (0.9)	0.9	0.8	-
Cu	Scaling factor for U_{oc} ⁽¹⁾	>0...1 (0.08593)	0.08593	0.08419	-
Cr	Scaling factor for U_{oc} ⁽¹⁾	>0...1 (0.000109)	0.000109	0.0001476	m ² /W
Cg	Scaling factor for U_{oc} ⁽¹⁾	>0...1 (0.002514)	0.002514	0.001252	W/m ²
alpha	Temperature coefficient for I_{sc} ⁽²⁾	>0...1 (0.0004)	0.0004	0.0002	1/°C
beta	Temperature coefficient for U_{oc} ⁽¹⁾	-1...<0 (-0.004)	-0.004	-0.002	1/°C

(1) U_{oc} = Open circuit voltage of a solar panel

(2) I_{sc} = Short-circuit current (=max. current) of a solar panel

3.11.15.4 Simulation mode

Apart from the panel technology there is also a simulation mode to select. Four options:

Mode	Description
U/I	Controllable simulation. Voltage (U_{MPP} , in V) and current (I_{MPP} , in A) in the maximum power point (MPP) are variable during runtime. The purpose of this mode is to directly shift the MPP into various directions.
E/T	Controllable simulation. During runtime, the irradiation (E from german "Einstrahlung", in W/m^2) and surface temperature (T, in $^{\circ}C$) of the simulated solar panel are adjustable. This also impacts the curve and the resulting MPP. The purpose of this mode is to analyse the impact of temperature and/or irradiation on the performance of a solar panel.
DAY U/I	Automatic simulation run, processing a day trend curve consisting of up to 100,000 points defined by values for U_{MPP} , I_{MPP} and time.
DAY E/T	Automatic simulation run, processing a day trend curve consisting of up to 100,000 points defined by values for irradiation, temperature and time.

3.11.15.5 Day trend

The so-called day trend is a special simulation mode for long-term tests. It processes a curve consisting of up to 100,000 user-definable points. For every processed point on that curve, the PV curve is calculated anew.

Every point is defined by 3 values of which one is the dwell time. When defining long dwell times the day trend curve can be supported by an interpolation feature which can be optionally activated. It will calculate and set intermediate points between two succeeding curve points. Hence it should be considered to run the day trend with or without interpolation.

The day curve points have to be loaded into the device, either from a CSV file on USB stick or via digital interface. The user selects the number of points according to the requirements of the simulation.

Formats of the CSV files to load from USB stick when manually configuring the function:

- For mode **DAY E/T** (required file name format: PV_DAY_ET_<arbitrary_text>.csv)

	A	B	C	D
1	1	100	25	300000
2	2	101	25	2000
3	3	102	25	2000
4	4	103	25	2000
5	5	104	25	2000
6	6	105	25	2000
7	7	106	25	2000
8	8	107	25	2000
9	9	108	25	2000

Column A = **Index**

An ascending number between 1 and 100,000 (the first empty index will cause the simulation to stop)

Column B = **Irradiance (E)** in W/m^2

Allowed range: 0...1500

Column C = **Temperature (T)** in $^{\circ}C$

Allowed range: -40...80

Column D = **Dwell time** in milliseconds (ms)

Allowed range: 500...1.800.000

- For mode **DAY U/I** (required file name format: PV_DAY_UI_<arbitrary_text>.csv)



Attention! The values in columns B and C are real values which must not exceed the ratings of the device or the device will neglect to load the file.

	A	B	C	D
1	1	63.5	120.3	500
2	2	63.6	121.1	500
3	3	63.7	121.9	500
4	4	63.8	122.7	500
5	5	63.9	123.5	500
6	6	64	124.3	500
7	7	64.1	125.1	500
8	8	64.2	125.9	500
9	9	64.3	126.7	500

Column A = **Index**

An ascending number between 1 and 100,000 (the first empty index will cause the simulation to stop)

Column B = **Voltage U_{MPP}** in V

Allowed range: 0...rated output voltage of the device

Column C = **Current I_{MPP}** in A

Allowed range: 0...rated output current of the device

Column D = **Dwell time** in milliseconds (ms)

Allowed range: 500...1.800.000



The number format and the column separator in the CSV files is determined by the regional settings of the PC or the software used to create the files. The format must match the selection for the device setting "USB file separator format" in the General Settings menu of the device, else the device would neglect loading the file. For example, an american Excel should by default use the dot as decimal separator and the comma as column separator, which would match the selection "USB file separator format = US".

3.11.15.6 Interpolation

The interpolation feature can calculate and set intermediate steps when running the PV function in day trend mode, i. e. **DAY E/T** or **DAY U/I**. The calculation is always done between two succeeding points on the day trend curve. The dwell time of every curve point is adjustable between 500 and 1,800,000 milliseconds (see above, format of the day trend data file). While there are no extra points calculated when using the minimum time of 500 ms, following applies to higher dwell time definitions:

- The number of intermediate steps is determined from the dwell time and spread as equally as possible, where any of the steps can have its own dwell time between 500 and 999 ms
- The intermediate steps also respect the slope between the current and the next day trend curve point and thus every step also includes a corresponding value alteration

Visualization:

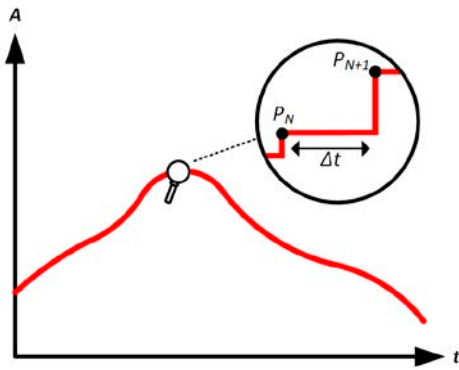

Without interpolation - the curve results in steps

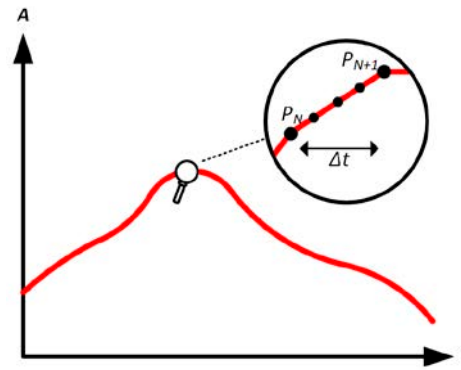

With interpolation - the curve remains linear

An example: the dwell time of the 3450th curve point is defined as 3 minutes, which is 180 seconds. There will be $180 / 0.5 - 1 = 359$ intermediate steps calculated and set until reaching the 3451st point. In mode DAY U/I the MPP voltage changes from 75 V to 80 V and the MPP current changes from 18 A to 19 A. When calculated, this would mean a $\Delta U/\Delta t$ of 27.7 mV/s and a $\Delta I/\Delta t$ of 5.5 mA/s. Depending on the device in use, such small steps in voltage or current may not be doable. However, the device would try to set the first intermediate step with 75.0138 V and 18.0027 A.

3.11.15.7 Data recording

There is the option to record data during the simulation run, in any mode. The data can be stored to USB stick once the simulation is finished or read via digital interface, which even allows for reading the data while the simulation is still running.

As long as the simulation is running, the device will record one data set every 100 ms into an internal buffer. This interval is not adjustable. The max. number of data sets, here also called indexes, is 576,000. This results in a max. record time of 16 hours. The indexes are internally counted with every new record. When reaching the max. number, the index will restart from 1, overwriting former data. Every index will contain 6 values.

When configuring the PV simulation, the recording feature is locked at first (button grayed out). Only when stopping the simulation and leaving the control screen back to the configuration, the button becomes accessible. It then allows to store a CSV with a specific number of rows. This number depends on the current index counter. Contrary to remote control where it's possible to address every index of the max. 576,000 the save to USB feature will always store all indexes between 1 and the counter. Every next simulation run also resets the counter.

CSV file format when saving the recorded data to USB stick (in the example all values are with unit):

	A	B	C	D	E	F	G
1	Index	U actual	I actual	P actual	Umpp	Impp	Pmpp
2	1	0,29V	0,000A	0,0W	0,00V	0,000A	0,0W
3	2	0,29V	0,000A	0,0W	0,00V	0,000A	0,0W
4	3	0,29V	0,000A	0,0W	0,00V	0,000A	0,0W
5	4	0,29V	0,000A	0,0W	0,00V	0,000A	0,0W
6	5	0,30V	0,000A	0,0W	0,00V	0,000A	0,0W
7	6	0,28V	0,000A	0,0W	0,00V	0,000A	0,0W
8	7	0,28V	0,000A	0,0W	0,00V	0,000A	0,0W
9	8	0,28V	0,000A	0,0W	0,00V	0,000A	0,0W

Index = Ascending number

Uactual = Actual voltage on the DC output

Iactual = Actual current on the DC output

Pactual = Actual power on the DC output

Umpp / Impp / Pmpp = Voltage, current and power in the MPP of the currently calculated PV curve

3.11.15.8 Configuration step by step

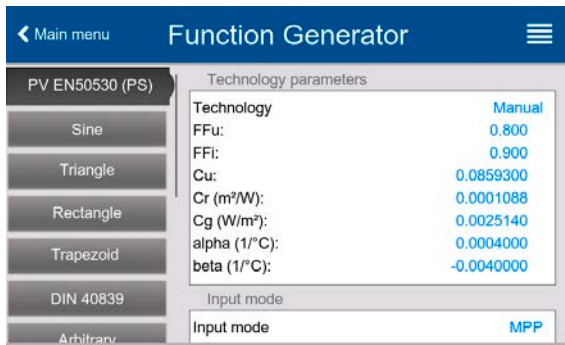

Starting point

In menu **Function Generator** find the PV functions. Select here group **PV EN50530 (PS)**.

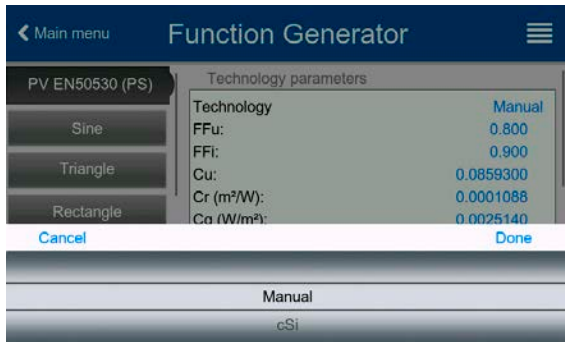

Step 1: Technology selection

The extended PV function requires to select the panel technology of the solar panel which is going to be simulated. In case **cSi** or **Thin Film** don't match your requirements or you are not sure about their technology parameters, select **Manual**.

When selecting **Thin film** or **cSi** the configuration continues with **Step 2**.

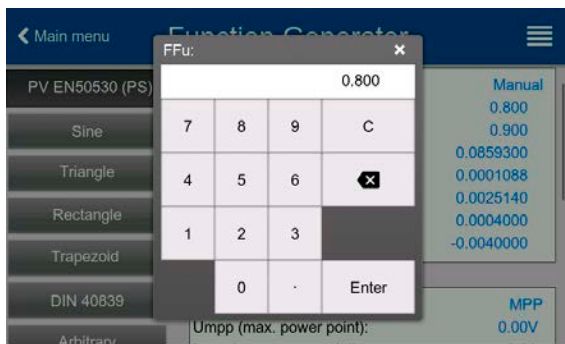

Step 1-1: Adjust technology parameters

If technology **Manual** was selected in the previous screen, all displayed technology parameters can be adjusted by tapping on them and entering the desired value. It's recommended to adjust these values very carefully, because wrong settings can result in a PV curve which doesn't work as expected.

When resetting the device, these values are reset to defaults which are the same as with technology **cSi**. Also see the overview in 3.11.15.3. It means they don't necessarily have to be adjusted. If any of the other technologies was selected, this screen would be skipped and these parameters set to the defined values.

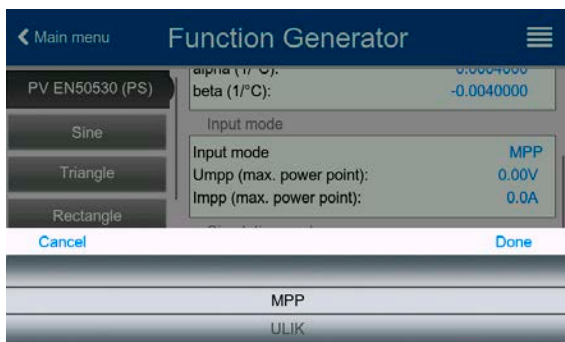

Step 2: Input mode and solar panel base parameters

Selecting the input mode between **MPP** and **ULIK** determines what pair of parameters has to be set in the configuration and also later in the simulation. When setting pair U_{oc}/I_{sc} , the other two pair is calculated with factors and automatically set.

The open circuit voltage (**Uoc**) and the short-circuit current (**Isc**) are upper limits which are usually read from the data sheet of a solar panel and entered here for the simulation. Two parameters each are connected via the fill factors:

$$U_{MPP} = U_{OC} \times FFu \quad / \quad I_{MPP} = I_{SC} \times FFi$$

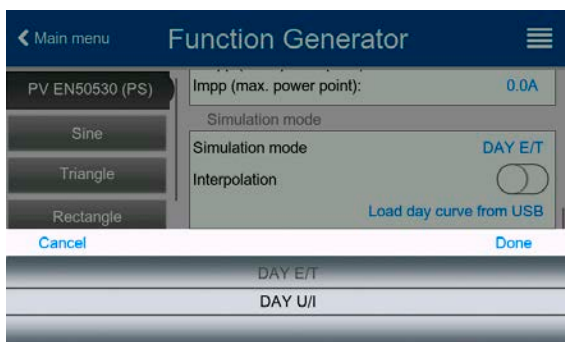

Step 3: Select simulation mode

For a description of the available simulation modes see 3.11.15.4.

When selecting **E/T** or **U/I** the configuration continues with **Step 4**, otherwise an additional step is required

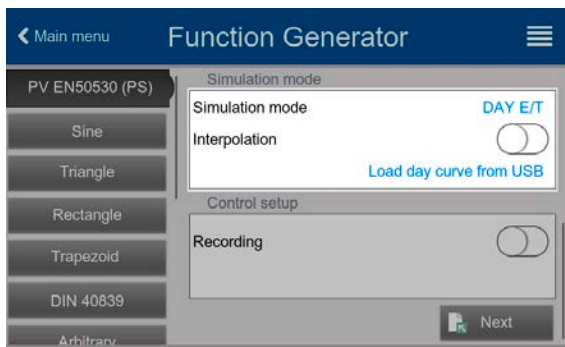

Step 3-1: Load day trend data

If mode **DAY E/T** or **DAY U/I** is selected you are required to load a curve with day trend data (1-100,000 points) with **Load day curve from USB** stick, in form of a CSV file with a specific format (see 3.11.15.5) and name (see 1.9.6.5).

There is furthermore the option to enable (=activate) the interpolation feature. For more about interpolation see 3.11.15.6.

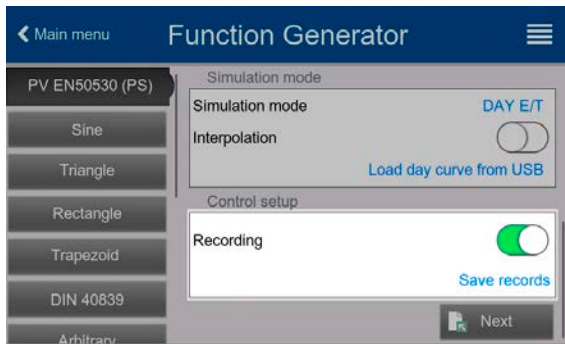

Step 4: Rest

One of the last two steps is the option to enable the recording feature which collects other data than you would get from the regular USB recording. The data is not stored directly to USB stick, but after stopping the simulation and coming back to this screen with the now available button **Save records**. Also see 3.11.15.7.

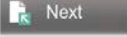
Proceed to the next screen with . Here you can adjust global set values for voltage and current. These are already set to levels suitable for the simulation.

The configuration will be finished and the settings submitted with button . The function generator would then switch to control mode.

3.11.15.9 Controlling the simulation

After loading the configured parameters the FG will switch to control mode. Now the simulation can be started with either the On/Off button or touch area .

According to the configured simulation mode, the orange-brown display area would show the adjustable simulation parameters, which could **only be modified via direct input**, not by the rotary knobs, because with every step of the knob the curve would be re-calculated.

The screen example on the right shows simulation mode **E/T**.

In case any of the day trend modes would have been configured, the display area would be empty. These modes run automatically once started and will stop when the total time of all points' dwell time is reached. The other modes, **E/T** and **U/I**, would only stop by user interaction or due to a device alarm.

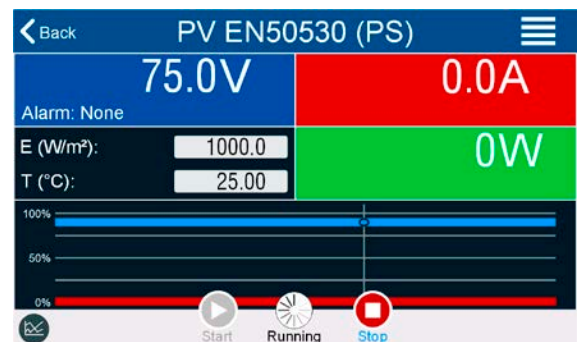

3.11.15.10 Stop criteria

The simulation run could unintentionally stop due to several reasons:

1. A device alarm occurred, which would switch off the DC output (PF, OVP, OCP, OPP)
2. A user event occurred whose action has been defined to cause an alarm, which means to switch off DC

Situation 2 can be avoided by carefully setting up other parameters, unrelated to the function generator. With the simulation stop in all three situation the data recording would also stop.

3.11.15.11 Test analysis

After simulation stop by whatever reason recorded data can be saved to USB stick or read via digital interface, of course only if data recording has been activated in the configuration. Activating the data recording feature during the simulation run is not possible when manually controlling the FG, but in remote control. When saving to USB stick, it would always save all data recorded until the current index counter. Via digital interface there is the option to read any portion of the data, which will also have an impact on the time required to read the data.

The data can later be used to visualize, analyze and determine characteristics of the simulated solar panel and also of the solar inverter which is usually used as load when running such tests. More details can be found in the standard paper.

3.11.15.12 Storing the PV curve

The last PV curve (or table) which has been calculated during the simulation run can later be read from the device via digital interface (partly or completely) or stored to USB stick. This can serve to verify the adjusted parameters. When running mode DAY E/T or DAY U/I this makes less sense, because there the curve would re-calculated with every processed index and the read curve would always be the one belonging to the last day trend curve point.

When reading the PV table, you will receive up to 4096 current values. The table data could be visualized in an XY diagram in tools like Excel.

3.11.16 Battery test function



The battery test function is only a feature to test batteries. It has no battery management functionality. It means, that there is no monitoring of single battery cells. Dead cells cannot be detected and in case there is at least one dead cell in a battery when being charged or discharged by the device, the battery could be destroyed. External battery management hardware and software might be required.

The purpose of the battery test function is to charge and discharge various battery types in industrial product tests or laboratory applications. Besides separate modes for charging and discharging of a battery, there is also a combination of both available, the so-called dynamic test. This form of test flow is available on the HMI as well as in **EA Power Control** (license based extra which isn't free of charge), but not in digital or analog remote control.

Users programming the device in remote control can achieve a similar flow by configuring the charging test separately from the static or dynamic discharge test and control everything accordingly.

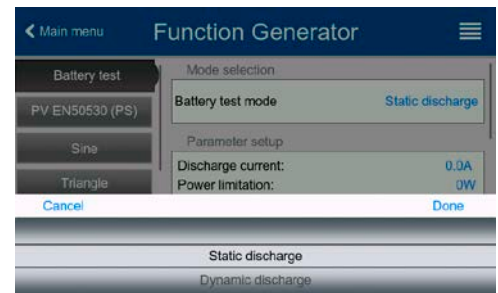

There is a choice of modes: **Static discharge** (constant current), **Dynamic discharge** (pulsed current), **Static charge** (constant current) and **Dynamic test** (flow of charge/discharge).

In **Static discharge** mode which by default runs in constant current (CC), the settings for power or resistance can also let the device run the function in constant power (CP) or constant resistance (CR). Like with the normal operation of the device the set values determine what regulation mode (CC, CP, CR) will be in effect. If, for example, CP operation is projected, the set value of current should be set to maximum and resistance mode should be turned off, so that both don't interfere. For a projected CR operation it's similar. Current and power should then be set to maximum.

For **Dynamic discharge** mode there is also a power setting, but it can't be used to run the dynamic battery test function in pulsed power mode or at least the result would not be as expected. It's recommended to always adjust the power value according to the test parameters, so it doesn't interfere with the pulsed current.



When discharging with high currents and in dynamic mode, it may happen that the battery voltage shortly drops below the U-DV threshold and the test will unintentionally stop. Here it's recommended to adjust U-DV accordingly.

Graphical depiction of both discharging modes:

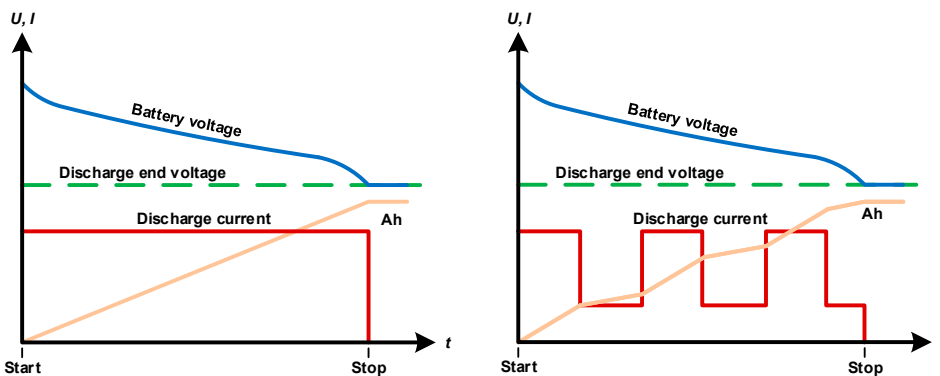

Static discharge

Dynamic discharge

The **Static charge** basically follows the charging profile used for lead-acid batteries. The battery is charged with a constant current until it reaches either a specified charging end voltage or a charging end time or when the charging current falls below the specified charging end current threshold.

Graphical depiction of the static charging mode:

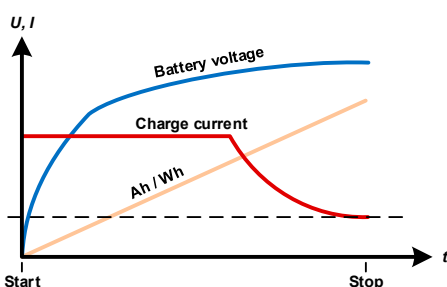

The fourth mode is called **Dynamic test** and combines **Static discharge** with **Static charge** in one flow. The same parameters for the single test parts are available, plus some extra for the flow. You can, for example, select what comes first, charge or discharge. There is also an option to cycle the test, i. e. repeat 1 to 999 times or infinitely and you can define a resting period which elapsed before the next cycle.

3.11.16.1 Settings for the static discharge mode

The following parameters can be configured for the static discharge battery test function:

Value	Range	Description
Discharge current	0...I _{Nom}	Maximum discharge current (in Ampere)
Power limitation	0...P _{Nom}	Maximum discharge power (in Watt)
R mode	on/off	Enables the resistance mode for the test and unlocks the R value
Discharge resistance	R _{Min} ...R _{Max}	Maximum discharge resistance in Ω

3.11.16.2 Settings for the dynamic discharge mode

The following parameters can be configured for the dynamic discharge battery test function:

Value	Range	Description
Discharge current 1	0...I _{Nom}	Upper resp. lower current setting for pulsed operation (the higher value of both is automatically used as upper level)
Discharge current 2	0...I _{Nom}	
Power limitation	0...P _{Nom}	Maximum discharge power (in Watt)
Time t1	1...36000 s	t1 = Time for the upper level of the pulsed current (pulse)
Time t2	1...36000 s	t2 = Time for the lower level of the pulsed current (pause)

3.11.16.3 Settings for the static charge mode

The following parameters can be configured for the static charge battery test function:

Value	Range	Description
Charge voltage	0...U _{Nom}	Charging voltage (in Volt)
Charge current	0...I _{Nom}	Maximum charging current (in Ampere)
Charge end current	0...I _{Nom}	Current threshold (in Ampere) upon which the charging would stop

3.11.16.4 Settings for the dynamic test mode

The following parameters can be configured for the dynamic test battery test function:

Value	Range	Description
Charge end current	0...I _{Nom}	Threshold (in Ampere) upon which the charging part would stop
Charge voltage	0...U _{Nom}	Charging voltage (in Volt)
Charge current	0...I _{Nom}	Static charging current (in Ampere)
Charge time	1...36000 s	Duration of the charging part (max. 10 h)
Discharge end voltage	0...U _{Nom}	Threshold (in Volt) upon which the discharging part would stop
Discharge current	0...I _{Nom}	Static discharging current (in Ampere)
Discharge time	1...36000 s	Duration of the discharging part
Start with	Charge Discharge	Determines whether the test starts with charging or discharging
Test cycles	0...65535	Number of cycles to run the complete test (0 = infinite cycles)
Rest time	1...36000 s	Time to rest the test before the next phase or cycle

3.11.16.5 Stop conditions

These parameters are valid for all test modes and define additionally stop conditions:

Value	Range	Description
Discharge end voltage	0...U _{Nom}	Threshold (in Volt) to stop discharging (only for discharge modes)
Action: Ah limit	None, Signal, End of test	Enables the optional stop condition

Value	Range	Description
Discharge capacity Charge capacity Test capacity	0...99999.99 Ah	Threshold for the max. capacity to consume from or feed to the battery and after which the test can stop automatically. This is optional, so that also more battery capacity can be consumed or supplied.
Action: Time limit	None, Signal, End of test	Enables the optional stop condition
Discharge time Charge time Test time	0...10 h	Test time after which the test can stop automatically. This stop criteria is optional, it means that single tests can also run longer than 10 h.
USB logging	on/off	By setting the check mark, USB logging is enabled and will record data on a properly formatted USB stick, if plugged in to the front USB port. The recorded data differs from the USB log data recorded during "normal" USB logging in all other operation modes of the device.
Logging interval	100 ms - 1 s, 5 s, 10 s	Writing interval for USB logging

3.11.16.6 Displayed values

During the test run, the display will show various values and statuses:

- Actual battery voltage on the DC terminal
- Discharge end voltage U_{DV} in V (only in discharge mode)
- Charge voltage in V (only in charge mode)
- Actual discharge or charge current
- Actual power
- Total battery capacity (charging & discharging)
- Total battery energy (charging & discharging)
- Elapsed time
- Regulation mode (CC, CP, CR, CV)

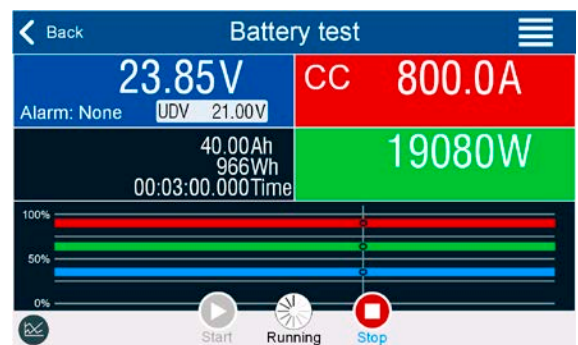

Figure 17 - Example from static discharge

3.11.16.7 Data recording to USB stick

At the end of the configuration of all test modes there is the option to enable a logging feature. With a USB stick plugged and formatted as required (see 1.9.6.5), the device can record data during the test run directly to the stick and in the defined interval. Active USB logging is indicated in the display with a small diskette symbol. After the test has stopped, the recorded data will be available as text file in CSV format.

Log file format example from static discharge mode:

	A	B	C	D	E	F	G
1	Static:Uset	Iset	Pset	Rset	DV	DT	DC
2	0,00V	0,00A	1200W	OFF	0,00V	10:00:00	99999,00Ah
3							
4	Uactual	Iactual	Pactual	Ah	Wh	Time	
5	0,34V	0,00A	0W	0,00Ah	0,00Wh	00:00:00,800	
6	0,28V	0,00A	0W	0,00Ah	0,00Wh	00:00:01,800	
7	0,28V	0,00A	0W	0,00Ah	0,00Wh	00:00:02,800	
8	0,28V	0,00A	0W	0,00Ah	0,00Wh	00:00:03,800	

Static = Selected test mode
Iset = Discharging current
Pset = Max. power
Rset = Desired resistance
DV = Discharge end voltage
DT = Discharge end time
DC = Discharge end capacity
U/I/Pactual = Actual values
Ah = Consumed battery capacity
Wh = Consumed energy
Time = Elapsed test time

3.11.16.8 Possible reasons for battery test stop

The battery test function run can be stopped by different reasons:

- Manual stop on the HMI with button "Stop"
- After the max. test time has been reached and action **End of test** was set for it
- After the max. battery capacity to consume has been reached and action **End of test** was set for it
- Any device alarm which would also switch off the DC input, like OT
- Reaching the threshold U_{DV} (discharge end voltage)
- Reaching the threshold for charging end current

3.11.17 MPP tracking function

MPP stands for the maximum power point (see principle view to the right) on the power curve of solar panels. Solar inverters, when connected to such panels, constantly track this MPP once it has been found.

The device imitates this behavior in sink mode. It can be used to test even huge solar panels without having to connect a usually big solar inverter device which also requires to have a load connected to its AC output. Furthermore, all MPP tracking related parameters of the load can be adjusted and it's thus more flexible than an inverter with its limited DC input range.

For evaluation and analysis purposes, the device can also record measured data, i. e. DC input values such as actual voltage, current or power, to USB stick or provide them for reading via digital interface.

The MPP tracking function offers **four modes**. Unlike with the manual handling of other functions, values for the MPP tracking are only entered by direct input via the touch screen.

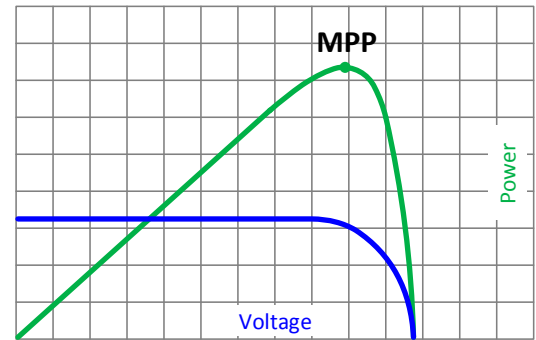
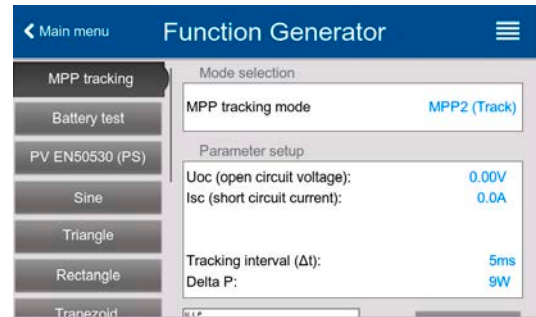

3.11.17.1 Mode MPP1

This mode is also called "Find MPP". It's the simplest option to have the device find the MPP of a connected solar panel. It requires to set only three parameters. Value U_{oc} is necessary, because it helps to find the MPP quicker as if the device would start at 0 V or maximum voltage. Actually, it would start at a voltage level slightly above U_{oc} .

I_{sc} is used as a upper limit for the current, so the device would not try to draw more current than the panel is specified for. Following parameters can be configured for tracking mode **MPP1**:

Value	Range	Description
U_{oc} (open circuit voltage)	0... U_{Nom}	Voltage of the unloaded solar panel, taken from the panel specs
I_{sc} (short-circuit current)	0... I_{Nom}	Short-circuit current, taken from the panel specs
Tracking interval (Δt)	5...60000 ms	Time between two tracking attempts when finding the MPP

Application and result:

After the three parameters have been set, the function can be started. As soon as the MPP has been found, the function will stop and switch off the DC input. The acquired MPP values of voltage (U_{MPP}), current (I_{MPP}) and power (P_{MPP}) would then be shown in the display.

The time of a function run depends on the parameter Δt . Even with the minimum setting of 5 ms one run usually takes already a few seconds.

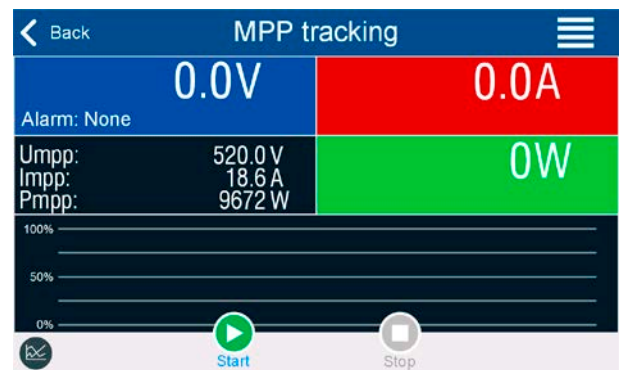

3.11.17.2 Mode MPP2

This mode tracks the MPP, so it's closest to the operation of a real solar inverter. Once the MPP is found, the function won't stop, but try to track the MPP permanently. Due to the nature of solar panels this can only be done below the level of the MPP. As soon as this point is reached, the voltage starts to sink further and so does the actual power. The additional parameter **Delta P** defines how much the power may fall before the direction is reversed and the voltage starts to rise again until the load reaches the MPP. The result are zigzag shaped curves of both, voltage and current.

Typical curves are shown in the picture to the right. For the example the **Delta P** was set to a quite small value, so the power curve looks almost linear. With a small **Delta P** the load would always track close to the MPP.

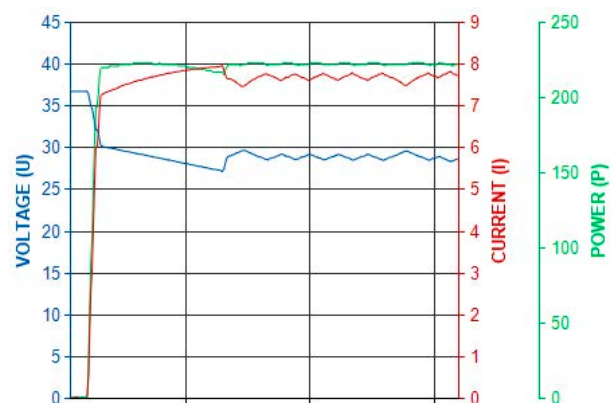

Following parameters can be configured for tracking mode **MPP2**:

Value	Range	Description
U_{oc} (open circuit voltage)	0...U _{Nom}	Voltage of the unloaded solar panel, taken from the panel specs
I_{sc} (short-circuit current)	0...I _{Nom}	Short-circuit current, taken from the panel specs
Tracking interval (Δt)	5...60000 ms	Interval for measuring U and I while finding the MPP
Delta P	0...P _{Nom}	Tracking/regulation tolerance below the MPP

3.11.17.3 Mode MPP3

Also called “fast track”, this mode is very similar to mode MPP2, but without the initial step which is used to find the actual MPP, because mode MPP3 would directly jump to the power point defined by user input (U_{MPP}, P_{MPP}). In case the MPP values of the equipment under test are known, this can save a lot of time in repetitive tests. The rest of the function run is the same as with MPP2 mode. During and after the function, the least acquired MPP values of voltage (U_{MPP}), current (I_{MPP}) and power (P_{MPP}) are shown in the display.

Following parameters can be configured for tracking mode **MPP3**:

Value	Range	Description
U_{oc} (open circuit voltage)	0...U _{Nom}	Voltage of the unloaded solar panel, taken from the panel specs
I_{sc} (short-circuit current)	0...I _{Nom}	Short-circuit current, taken from the panel specs
U_{MPP} (max. power point)	0...U _{Nom}	Voltage in the MPP
P_{MPP} (max. power point)	0...P _{Nom}	Power in the MPP
Tracking interval (Δt)	5...60000 ms	Interval for measuring U and I while finding the MPP
Delta P	0...P _{Nom}	Tracking/regulation tolerance below the MPP

3.11.17.4 Mode MPP4

This mode is different to the others, because it does not track automatically. It rather offers the choice to define a user curve by setting up to 100 points of voltage values, then track this curve, measure current and power and return the results in up to 100 sets of acquired data. The curve points can only be loaded from a USB stick. Start and end point can be adjusted as well, Δt defines the time between two points and the function run can be repeated up to 65535 times. Once the function stops at the end or due to manual interrupt, the DC input is switched off and the measured data is made available. After the function, the acquired set of data with the highest actual power will be shown in the display as voltage (U_{MPP}), current (I_{MPP}) and power (P_{MPP}) of the MPP. Going back on the screen with **Back** then allows for data export of the 100 measured results to USB stick.

Following parameters can be configured for tracking mode **MPP4**:

Value	Range	Description
Start	1...End	Start point for the run of x out of 100 subsequent points
End	Start...100	End point for the run of x out of 100 subsequent points
Repetitions	0...65535	Number of repetitions for the run from Start to End
Tracking interval (Δt)	5...60000 ms	Time before the next point



3.11.17.5 Load curve data from USB stick for mode MPP4

Curve point data (only one voltage value per point), in form of a CSV file, is loaded from USB stick. See section 1.9.6.5 for the naming convention. Contrary to manual adjustment where you can define and use an arbitrary number of points, loading from USB requires the CSV file to always contain the full number of points (100), because it can't define which one is start and end. However, the on-screen setting for **Start** and **End** point remain valid. It means, if you actually want to use all 100 points from your loaded curve, you must set the parameters according.

File format definition:

- The file must be a text file with appendix *.csv
- The file must contain only one column of voltage values (0... rated voltage)
- The file must exactly 100 values in 100 rows, no gaps
- The decimal separator of broken values must follow the setting “Log file separator format” where selection **US** means dot as decimal separator and selection **Standard** means comma

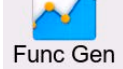
► How to load a curve data file for MPP4

1. While the DC terminal is switched off, enter the function generator by tapping on . In the selection swipe to find and tap on group **MPP Tracking**.
2. In the area "Mode selection" select **MPP4 (User curve)**. In the lower part under "Parameter" a new tap field **Load MPP4 voltage values** will appear. Tap it.
3. Insert USB stick, if not already done.
4. The next screen searches the stick for compatible files and lists them. Tap the one you want to load and confirm with .

3.11.17.6 Save result data from MPP4 mode to USB stick

After the MPP4 function has run through, the result data can be saved to USB stick. The device will always save 100 data sets consisting of the actual values of voltage, current and power belonging to the points it has run through. There is no extra numbering. In case the settings **Start** and **End** were not 1 and 100, the true result data can later be filtered from the file. Points which were not adjusted are automatically set to 0 V, thus it's very important to carefully adjust start and end point because with a voltage setting of 0 V an electronic load would draw its rated current. That's because in this mode, current and power are always set to max.

Format of the result data file (for naming convention see section 1.9.6.5):

	A	B	C
1	1,01V	20,960A	21,0W
2	2,99V	20,970A	63,0W
3	3,99V	20,970A	84,0W
4	5,99V	20,940A	125,0W
5	7,00V	20,920A	146,0W
6	8,00V	20,930A	168,0W
7	9,00V	20,950A	188,0W
8	9,99V	20,960A	210,0W
9	10,99V	20,970A	231,0W



Legend:

- Column A: actual voltage of points 1-100 (= U_{MPP})
- Column B: actual current of points 1-100 (= I_{MPP})
- Column C: actual power of points 1-100 (= P_{MPP})
- Rows 1-100: result data sets of all possible curve points



The values in the example table to the left are with physical units. If that's not wanted, they can be turned off in the "General settings" of the device with parameter "USB logging with units (V,A,W)".

► How to save a curve data file for MPP4

1. After the function has run through, it will stop automatically. Tap on **Back** to go back to the MPP4 configuration screen.
2. Insert a USB stick, if not already done.
3. Below the  button tap on **Save records**. The next screen searches the stick for compatible files and lists them. Either tap one to select it (overwrite) or don't select any file to create a new file and confirm with .

3.11.18 Remote control of the function generator

The function generator can be remotely controlled, but configuration and control of the functions with individual commands is different from manual operation. The external documentation "Programming Guide ModBus & SCPI" on the included USB stick explains the approach. In general the following items apply:

- The function generator isn't directly controllable via the analog interface; the only impact to the function run can come from pin REM-SB switching the DC terminal off and on, which will also stop and restart the function
- The function generator is unavailable if R mode (resistance) is activated

3.12 Other applications

3.12.1 Parallel operation in master-slave (MS)

Multiple devices of same kind can be connected in parallel in order to create a system with higher total current and hence higher power. For parallel operation in master-slave mode the units are usually connected with their DC terminals, their Share bus and their master-slave bus, which is a digital bus that makes the system work as one big unit regarding adjusted values, actual values and status.

The Share bus is intended to balance the units dynamically in their voltage on the DC terminal, i.e. in CV mode, especially if the master unit runs a dynamic function. In order for this bus to work correctly, at least the DC minus poles of all units have to be connected, because DC minus is the reference for the Share bus.

Principle view (without load or source):

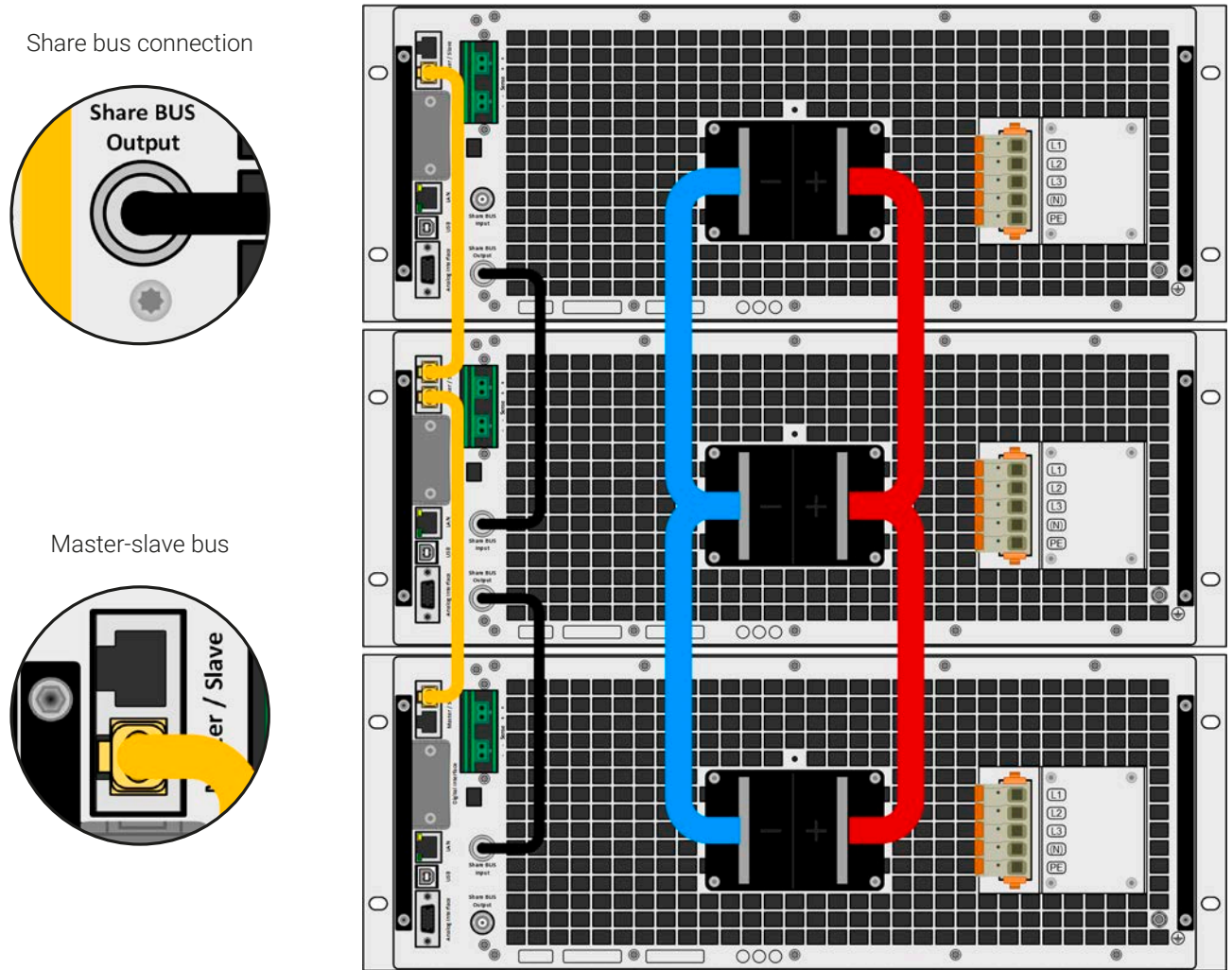

3.12.1.1 Restrictions

Compared to normal operation of a single device, master-slave operation has some restrictions:

- The MS system reacts partly different in alarm situations (see below in 3.12.1.8)
- Using the Share bus makes the system react as dynamic as possible, but it's still not as dynamic as single unit operation
- Connection to identical models from other series is supported, but limited to PSBE 10000 series which can serve as slave units

3.12.1.2 Wiring the DC terminals

The DC terminal of every unit in the parallel operation is connected with correct polarity to the next unit, using cables or copper bars with a cross section according to the total system current and with short as possible length, so their inductance is as low as possible.

3.12.1.3 Wiring the Share bus

The Share bus is wired from unit to unit with standard BNC cables (coaxial, 50 Ω type) with a length of 0.5 m (1.64 ft) or similar. Both sockets are internally connected and are not specifically input or output. The labeling is only for orientation.



- A max. of 64 units can be connected via Share bus.
- When connecting the Share bus before a device had been configured as Master or Slave, an SF alarm will occur

3.12.1.4 Wiring and set-up of the digital master-slave bus

The master-slave connectors are built-in and can be connected via network cables (≥CAT3, patch cable). After this, MS can be configured manually or by remote control. The following applies:

- A maximum of 64 units can be connected via the bus: 1 master and up to 63 slaves.
- Connection only between devices of same kind, i.e. power supply to power supply; connection of different power classes is allowed and supported, e. g. one 15 kW 3U with one 30 kW 4U to achieve a total of 45 kW, but requires to have at least firmware KE/HMI 3.02 or higher installed on all units
- Linking different series is supported, but limited to:
 - PSBE 10000 series models can be used as slave units for PSB 10000 series models being the master unit
- Units at the end of the bus should be terminated, if necessary (see below for more information)



The master-slave bus must not be wired using crossover cables!

Later operation of the MS system implies:

- The master unit displays, or makes available to be read by the remote controller, the sum of the actual values of all the units
- The ranges for setting the values, adjustment limits, protections (OVP etc.) and user events (UVD etc.) of the master are adapted to the total number of units. Thus, if e.g. 5 units each with a power of 30 kW are connected to a 150 kW system, then the master can be set in the range 0...150 kW.
- Slaves are no operable as long as being controlled by the master
- Slave units will show the alarm "MSP" in the display as long as they not have been initialized by the master. The same alarm is signaled after a connection drop to the master unit occurred.
- In case the function generator of the master unit is going to be used, the Share bus must be connected as well

► How to connect the digital master-slave bus

1. Switch off all units and connect the master-slave bus with network cables (CAT3 or better, cables not included). It doesn't matter which of the two master-slave sockets (RJ45, backside) is connected to the next unit.
2. Depending on the desired configuration the units are then also connected at their DC terminals. The two units at the beginning and end of the chain must be terminated, while the master requires a separate setting. See table below.

Termination is done with internal electronic switches which are controlled from within the **Settings** menu of the device in group **Master-slave**. This can be done as part of setting up every unit as master or slave, but should be done before the master is going to be set as **Master**, because doing so immediately triggers a bus initialization. In group **Master-Slave** the termination resistors for BIAS and the bus itself (TERM, see figure to the right) can be set separately. Settings matrix for the units on the MS bus:

Device position	Termination setting(s)
Master (at end of bus)	BIAS + TERM
Master (central in bus)	BIAS
Slave (at end of bus)	TERM
Slave (central in bus)	-

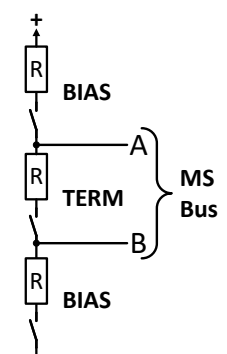

3.12.1.5 Mixed systems

As mixed systems following is understood:

- Different power classes, like 5 kW, 15 kW or 30 kW within one master-slave system (requires at firmware KE 3.02)
- Different series, specifically PSBE 10000 series in connection with PSB 10000 series (requires at firmware KE 3.02)

Both mixed systems are supported, but also their combination. The use of a "PSBE" series device as slave for a "PSB" series master wasn't possible before, because the PSBE had no resistance mode, contrary to the PSB. Today, this is circumvented by generally enabling resistance control for a PSBE. Vice versa, a PSBE cannot be the master of a PSB.

When connecting devices with different feature sets it makes sense to select the one with the best configuration as master.

Combining different power classes can have an unexpected side effect, such that the resulting total power, as displayed by the master after the initialization, isn't the expected one, but lower. This depends on what unit and power class has been picked as master. In such a situation the golden rule is: always select the master from the units with the highest power rating.

Example: you want to connect a 30 kW unit and a 3kW unit in order to achieve 33 kW. Generally, the voltage rating must match, but current and power rating can be different. To be precise, the power rating is decisive. When using the 3 kW unit as master, the total system power will only be 28 kW (with a master running firmware KE 3.02), which is even less than the single 30 kW unit. When, however, switching the master to the 30 kW unit, the system will result in 33 kW total power.

3.12.1.6 Configuring the master-slave operation

Now the master-slave system has to be configured on each unit. It's recommended to configure all the slave units first and then the master unit.

► Step 1: Configuring all slave units

1. While the DC output is switched off, tap on  in the main screen to access the **Settings** menu. Swipe up to find group **Master-slave** and tap it.
2. Tapping on the blue button text next to **Mode** will open a selector. By selecting **Slave**, if not already set, the master-slave mode is activated and the device is defined as slave. Additionally, the bus termination can be activated here, if required for the currently configured unit.
3. Leave the Settings menu.

After this, the slave is fully configured for master-slave. Repeat the procedure for all other slave units.

► Step 2: Configuring the master unit

1. While the DC output is switched off, tap on  in the main screen to access the **Settings** menu. Swipe up to find group **Master-slave** and tap it.
2. Tapping on the blue button text next to **Mode** will open a selector. By selecting **Master**, if not already set, the master-slave mode is activated and the device is defined as master which also automatically enable the BIAS resistor termination, as required for the master.

► Step 3: Initializing the master

When setting a device to Master, it will instantly start to initialize the MS system and the result is displayed in the very same window. In case the initialization is not successful or the number of units or the total power is wrong, it can be repeated in this screen anytime.

Initialization state	Initialized
Number of slaves	1
System voltage	80.00V
System current	2000.0A
System power	60.00kW
System resistance	5.0000Ω
	Initialize system

Tapping **Initialize system** repeats the search for slaves in case the detected number of slaves is less than expected, the system has been reconfigured, not all slave units are already set as **Slave** or the cabling/termination is still not OK. The result window shows the number of slaves plus the total current, power and resistance of the MS system.

In case there are no slaves found at all, the master will still initialize the MS system with only itself.



As long as MS mode remains activated, the initialization process of the master-slave system will be repeated each time the master unit is powered. The initialization can also be repeated manually anytime via the Settings menu, in group "Master-Slave".

3.12.1.7 Operating the master-slave system

After successful configuration and initialization of the master and slave units, they will show their status in the in the status area of their displays. The master would show **MS mode: Master** while the slave(s) would show **MS mode: Slave** plus **Remote: Master-slave**, as long they are in remote control by the master.

From now on the slaves can no longer be controlled manually or remotely, neither via the analog nor via digital interfaces. They can, if needed, be monitored via these interfaces by reading actual values and status.

The display on the master unit will reconfigure after initialization and all set values are reset. The master now displays the set and actual values of the total system. Depending on the number of units, the adjustable current and power range will multiply, while the resistance range will decrease. Then following applies:

- The system, represented by the master, can be treated like a standalone unit
- The master shares the set values etc. across the slaves and controls them
- The master is remotely controllable via the analog or digital interfaces
- All settings for the set values U, I, P and R on the master, plus also all related values from supervision, limits etc. should be adapted to the new total values
- All initialized slaves will reset any limits (U_{Min} , I_{Max} etc.), supervision thresholds (OVP, OPP etc.) and event settings (UCD, OVD etc.) to default values, so these don't interfere the control by the master. As soon as these values are modified on the master, they are transferred 1:1 to the slaves. Later, during operation, it might occur that a slave causes an alarm or an event earlier than the master, due to imbalanced current or slightly faster reaction.



In order to easily restore all these settings to what was configured before activating MS operation, it's recommended to make use of the user profiles (see "3.10. Loading and saving user profiles")

- If one or more slaves report a device alarm, it will be signaled on the master and must be acknowledged also there. so that the slave(s) can continue their operation. Since an alarm causes the DC terminals to be switched off and can only reinstate the on/off condition automatically after PF or OT alarms, where the reaction to the alarms is configurable, action from an operator or a remote control software may become necessary.
- Loss of connection to any slave will result in shutdown of all DC terminals as a safety measure and the master will report this situation in the display with a pop-up telling "Master-slave security mode". Then the MS system has to be re-initialized, either with or without prior re-establishment of the connection to the disconnected unit(s).
- All units, even the slaves, can be externally shut down on their DC terminals using the pin REM-SB of the analog interface. This can be used as some kind of "emergency off", here usually a contact (maker or breaker) is wired to this pin on all units in parallel.

3.12.1.8 Alarms and other problem situations

Master-slave operation, due to the connection of multiple units and their interaction, can cause additional problem situations which do not occur when operating individual units. For such occurrences the following regulations have been defined:

- Generally, if the master loses connection to any slave, it will generate an MSP (master-slave protection) alarm, pop up a message on the screen and switch off its DC terminal. The slaves will fall back to single operation mode and also switch off their DC terminal. The MSP alarm can be deleted by initializing the master-slave system again. This can be done either in the MSP alarm pop-up screen or in the MENU of the master or via remote control. Alternatively, the alarm is also cleared by deactivating master-slave on the master unit
- If one or more slave units are cut from AC supply (power switch, blackout, supply undervoltage) and come back later, they're not automatically initialized and included again in the MS system. Then the init has to be repeated.
- If the master unit is cut from AC supply (power switch, blackout) and comes back later, the unit will automatically initialize the MS system again, finding and integrating all active slaves. In this case, MS can be restored automatically.
- If accidentally multiple or no units are defined as master the master-slave system can't be initialized

In situations where one or multiple units generate a device alarm like OVP etc. following applies:

- Any alarm of a slave is indicated on the slave's display and on the master's display
- If multiple alarms happen simultaneously, the master only indicates the most recent one. In this case, the particular alarms can be read from the slave units displays or via digital interface by any software.
- All units in the MS system supervise their own values regarding overvoltage, overcurrent and overpower and in case of alarm they report the alarm to the master. In situations where the current is probably not balanced between the units, it can occur that one unit generates an OCP alarm though the global OCP limit of the MS system was not reached. The same can occur with the OPP alarm.

3.12.2 Series connection



Besides being able to work as a power supply, the device is also an electronic load.
Series connection in sink mode operation isn't supported and must thus not be connected and operated (can void warranty)!
Series connection in source mode operation only at one's own risk (can void warranty)!

Series connection in source mode operation is possible, but requires extra measures to ensure the device cannot enter sink mode. This is achieved by setting the power and current set values for sink mode to zero.

There is furthermore a technical limit of the achievable total voltage which depends on the strength of insulation of the DC plus and DC minus poles, as given in the technical specifications in 1.8.3. These specifications determine how many units with the same or different voltage rating can be operated in series and in case there are different models, it also determines which model can be in what position.

Basic rule: when connecting models with different voltage ratings in series, their current and power ratings are usually also different which result in a global current and power limit of the series that is defined by the unit with the smallest current or power rating.

3.12.3 SEMI F47

SEMI F47 (the SEMI comes from semiconductor) is a specification that demands a device to continue working without interruption in case of a power failure in form of an AC supply undervoltage (here: sag) of max. -50% of the rated line voltage with a max. duration of 1.7 seconds. From firmware KE 3.02 and HMI 3.02 this has been implemented for all 10000 series devices, but cannot be obtained by installing an update.

SEMI F47 specifies a AC supply voltage sag in steps of increasing voltage:

Sag of	Duration at 50 Hz	Duration at 60 Hz	Duration in seconds
50%	10 cycles	12 cycles	0.2
30%	25 cycles	30 cycles	0.5
20%	50 cycles	60 cycles	1 s

3.12.3.1 Restrictions

- The feature will be disabled automatically and also locked if the device boots with low AC supply voltage present, i. e. 208 V (L-L) instead of the default 400 V (L-L), so it could not bridge the 1.7 s duration of the F47 pulse anymore. It means that SEMI F47 isn't available while derating is active.
- It requires a decreased max. power, compared to the rated power of the particular model, thus SEMI F47 is also a sort of derating, but it's not depending on the line voltage but what the AC input circuit (PFC) can cover without running into a power fail. This reduced power rating is activated and deactivated together with SEMI F47

3.12.3.2 Adjustments

- SEMI F47 can either be activated/deactivated manually on the HMI (see 3.5.3.1) or a digital interface, unless blocked due to the current device state.

3.12.3.3 Application

The feature can be activated at any time, unless blocked to the current devices, for example when low voltage derating is already active (see 3.3.3.7). When activating it sometime during normal operation, the device will pop up a message after leaving the menu, informing about the altered situation and also instantly reduce the max. available power, as well as adjust the power set values, should the currently be higher than the new maximum. When deactivating the feature it goes vice versa, only the power set values remain unaltered then. Due to the fact that the setting is stored beyond shutting down the device, it could directly boot into SEMI F47 mode during next start, also showing that above mentioned pop-up once after the start (the pop-up can be deactivated).

If later a voltage sag occurs, the level of sag or the duration decides whether the device continues its operation without switching the DC output off or if it would show a **PF** alarm. Without SEMI F47 being activated, the PF alarm would appear immediately while with activated SEMI F47 it's delayed for at least 2 seconds or will never occur. In this case, the device wouldn't show any reaction to the sag, nor register the occurrence in any form.

4. Service and maintenance

4.1 Maintenance / cleaning

The device needs no recurring maintenance. Cleaning may be needed for the internal fans, the frequency of cleanse is depending on the ambient conditions. The fans serve to cool the components which are heated by the inherent power loss. Heavily dirt filled fans can lead to insufficient airflow and therefore the DC terminal would switch off too early due to over-heating or possibly lead to defects.

In case there is requirement for such a maintenance, please contact us.

4.1.1 Battery replacement

The device contains a Lithium cell battery of type CR2032, which is placed on the so-called KE board that is mounted to the right-hand side wall (when looking from the front) of the device. The battery is specified for a life span of at least 5 years, but due to ambient condition, especially temperature, this span could be lower. The battery is used to buffer the internal real-time clock and if it becomes necessary to replace the battery, it can be done on location by a qualified person while maintaining typical ESD precautionary measures. The KE board would have to be loosened and lifted up carefully to access the battery.

4.2 Fault finding / diagnosis / repair

If the equipment suddenly performs in an unexpected way, which indicates a fault, or it has an obvious defect, this can't and must not be repaired by the user. Contact the supplier in case of suspicion and elicit the steps to be taken.

It will then usually be necessary to return the device to the supplier (with or without guarantee). If a return for checking or repair is to be carried out, ensure that:

- the supplier has been contacted and it's clarified how and where the equipment should be sent.
- the device is in fully assembled state and in suitable transport packaging, ideally the original packaging.
- optional extras such as an interface module is included if this is in any way connected to the problem.
- a fault description in as much detail as possible is attached.
- if shipping destination is abroad, the necessary customs papers are attached.

4.2.1 Firmware updates



Firmware updates should only be installed when they can eliminate existing bugs in the firmware in the device or contain new features.

The firmware of the control panel (HMI), of the communication unit (KE) and the digital controller (DR), if necessary, is updated via the rear side USB port. For this the software EA Power Control is needed which is included with the device or available as download from our website together with the firmware update, or upon request.

However, be advised not to install updates promptly. Every update includes the risk of an inoperable device or system. We recommend to install updates only if...

- an imminent problem with your device can directly be solved, especially if we suggested to install an update during a support case
- a new feature has been added which you definitely want to use. In this case, the full responsibility is transferred to you.

Following also applies in connection with firmware updates:

- Simple changes in firmwares can have crucial effects on the application the devices are use in. We thus recommend to study the list of changes in the firmware history very thoroughly.
- Newly implemented features may require an updated documentation (user manual and/or programming guide, as well as LabVIEW VIs), which is often delivered only later, sometimes significantly later

4.2.2 Trouble-shooting device problems

Problem situation	Possible hazard	Probability	Safety measures to take by the operator	Residual risk
A voltage source with reversed polarity has been connected to the DC terminal	Damage of the internal secondary power stage	Low	With all application that require to connect an external source to the device, especially if the source is a battery, attach an extra warning sign onto the device which instructs the user to be extra careful, watching the polarity. As an additional measure include fuses in line with the DC cables which could attenuate or even prevent damage to the device.	Low

5. Contact and support

5.1 General

Repairs, if not otherwise arranged between supplier and customer, will be carried out by the manufacturer. For this the device must generally be returned to the manufacturer. No RMA number is needed. It's sufficient to package the equipment adequately and send it, together with a detailed description of the fault and, if still under guarantee, a copy of the invoice, to the following address.

5.2 Contact options

Questions or problems with operation of the device, use of optional components, with the documentation or software, can be addressed to technical support either by telephone or e-Mail.

Headquarter	eMail addresses	Telephone
EA Elektro-Automatik GmbH Helmholtzstr. 31-37 41747 Viersen Germany	Technical support: support@elektroautomatik.com All other topics: ea1974@elektroautomatik.com	Switchboard: +49 2162 / 37850 Support: +49 2162 / 378566

EA Elektro-Automatik GmbH & Co. KG

Helmholtzstr. 31-37
41747 Viersen

Phone: +49 (2162) 3785 - 0
Fax: +49 (2162) 16230
ea1974@elektroautomatik.com

www.elektroautomatik.com

EA Elektro-Automatik Inc.

7926 Convoy Court
CA, 92111, San Diego

Phone: +1 (858) 836 1300
sales@elektroautomatik.com

www.eapowered.com

